

1

Uniclass
Pr_35_90_43 / 86 / 20 / 15
Pr_25_71_14_62
Pr_25_30_36 / 96 / 03 / 63 / 84
CI/SfB
(42) X

WALL PROTECTION SYSTEMS

WALL, CORNER AND DOOR PROTECTION



GRADUS

GRADUS

Our products are installed in many prestigious buildings. With customers ranging from designers and architects to contractors and building owners you can trust Gradus to provide products that work.



Leicester Royal Infirmary



Liverpool Library



Royal Victoria Infirmary, Newcastle



Royal Sussex County Hospital, Brighton



The Grange University Hospital, Wales



The Christie, Proton Beam Therapy Centre



The Priory Ruskin Academy, Lincolnshire



Royal Liverpool University Hospital

Contents

NEW	Product Update	2	Wall Guards, Wall Strips & Bed Head Protectors	62
	Why Gradus	4	WGS200 Wall Guard	64
	Project Management & Installation Service	6	WGS125 Wall Guard	66
NEW	Sustainability		WGA100 Wall Guard	68
	Our Commitment to the Planet	8	WST150 & WST200 Wall Strips	70
	The Benefits of PVC	10	SSWG Stainless Steel Wall Guards	72
	Recycling: Part of our DNA	11	WGR Rubber Wall Guards	74
NEW	Fundamentals	12	BHPA100 Bed Head Protector	76
	An Introduction to Wall Protection	16	BHPA125 Bed Head Protector	78
	Building Zones		Handrails, Dual Rails & Combination Rail	80
	Healthcare Solutions	18	SHR40P Handrail	82
	Education Solutions	20	SHR40W Handrail	84
	Industry Solutions	22	SHR40S Handrail	86
	Selecting the right product		THR450 Timber Handrail	88
	Corridors & Circulation Areas	24	SSHR42 Stainless Steel Handrail	90
	Hospital Accommodation	26	D200P Dual Rail	92
	Clinical Areas / Industry	28	D200T Dual Rail	94
	Commercial Kitchens	30	D200W Dual Rail	95
	Education	32	D200S Dual Rail	96
	Manufacturing / Industry	34	CHR110 Combination Rail	98
	Back of House	36	CHR160 Combination Rail	100
	Colour		Corner Guards	102
	See through their eyes	38	High Impact PVC-u	104
	Tonal Contrast Guide	40	Standard PVC-u	106
	Colour Availability Chart	41	Adjustable Angle PVC-u	108
	Colour Availability	42	Clear PVC-u	108
	Wall Cladding Systems	44	Chequer Plate Aluminium	110
	SureProtect Endure	46	Stainless Steel	110
	SureProtect Pure	50	Rubber	112
	SureProtect Design	54	Reflective	112
NEW	SureProtect Artworx	56	Door Protection	114
	Gradus Grip Wall Cladding Adhesive	58	Door Face Protection	116
	Aluminium Chequer Plate	60	Fire Rated Door Edge Guards	119
	Stainless Steel Sheet	61	Door Frame Protection	120
			Floor Mounted Protection	122
			Stainless Steel Floor Rail System	124
			Stainless Steel Bollard	126
			Galvanised Steel Bollard with Cover Kits	127
			Steel Core Protection Posts	128
			Flexible Protection Posts	129
			Additional Information	
			Specification Guidelines	130
			Gradus PVC-u Product Characteristics	136

Product Update

NEW

SureProtect Artworx™

Gradus SureProtect Artworx offers wall cladding with a bespoke printed finish. It can be used to create stimulating and inspiring interiors where design is key but a level of protection is still required, for example, leisure, hospitality and healthcare applications.



- > Can be supplied in multiple sheets to create a continuous image
- > Made to measure with maximum dimensions of 3048mm x 1200mm
- > Artwork to be supplied by customer
- > See page 56



NEW

New Colour Palette

- > 8 brand new colours in SureProtect Endure, PVC-u wall guards, handrails and corner guards
- > 2 brand new SureProtect Design wood effects
- > Our PVC-u wall protection range is not just visually stunning but also built to withstand daily wear and tear, ensuring long-lasting protection for your walls
- > All Gradus Wall Protection colours are measured to provide Light Reflectance Values, so you can find the perfect shade to complement your project and ensure a suitable visual contrast is achieved
- > See pages 42 and 55 for more information

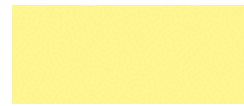

043 Mimosa



041 Terracotta



040 Lychee



042 Mulberry



048 Lagoon



046 Indigo

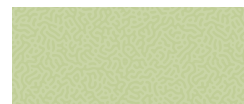

044 Sage



045 Fern

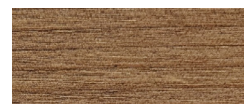

071 Cherry

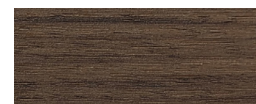

070 Walnut

NEW

PVC-u Continuous Retainers

- > Available in Wall Guards WGS200P and (WGS125P coming later this year) and High Impact Corner Guards
- > Suitable for gently undulating substrates due to their added flexibility
- > Made from up to 100% recycled waste material produced in the Gradus manufacturing plant
- > See pages 64, 66 and 104 for more information

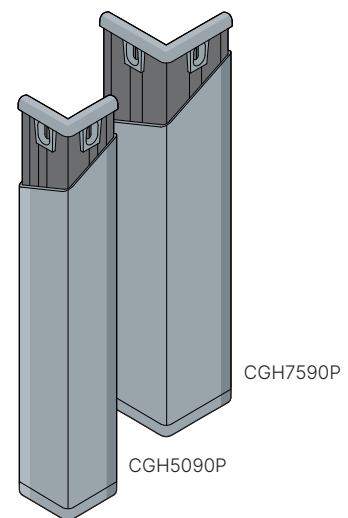

WGS200P

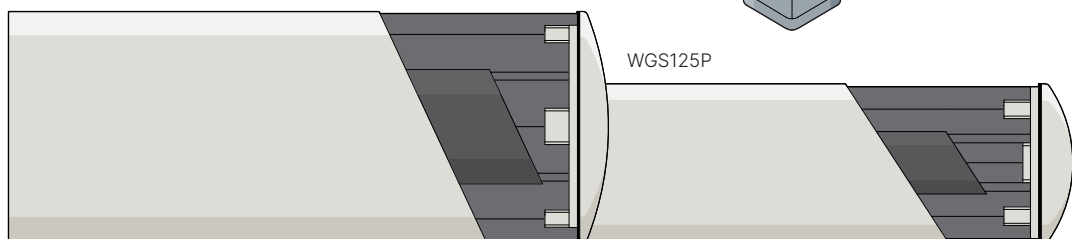

Why Gradus

Gradus has been manufacturing, supplying and fitting wall protection systems into the UK and International markets for over 25 Years and provides one of the most extensive wall protection systems available today.

With significant project expertise and a full installation service Gradus can provide expert support and advice from design through to the specification and installation.

Our comprehensive range includes vinyl and aluminium profiles designed specifically for the UK market comprising textured wall cladding, hygienic wall cladding, handrails, dual rails, combination rails, wall guards (crash rails, bumper bars), corner guards, bed head protectors and door protection.

All Gradus wall protection profiles have been designed to protect surfaces such as walls, corners and doors and provide an essential barrier against damage caused by the general flow of wheeled and pedestrian traffic.



Gradus is the largest UK manufacturer of wall protection profiles. Gradus controls the design of profiles from initial concept through to finished product, including specialist CAD design and the manufacture of tooling. This ensures that quality is maintained and provides customers with an efficient, flexible and fast service.



Gradus Springbank - Manufacturing plant for Wall Protection Systems
Macclesfield Cheshire UK



RIBA assessed CPD seminars

RIBA Assessed CPD Seminars

Gradus offer a RIBA approved CPD seminar that gives specifiers all the information they need to know to make the most effective decisions when specifying interior protection. Available on-site, virtually or hybrid, to suit your needs. With this seminar you'll learn why and how to specify wall protection, key protection zones and design considerations in buildings and the latest guidance and standards. For further information about our CPD or to book your place, contact Gradus on 01625 428922.

Food for Thought

An informal opportunity for Gradus to bring an exhibition of products directly to you. Flexible and informative, they can be arranged at a date and time to suit you.

Website

Visit www.gradus.com to access all products and services and to access downloads such as AutoCAD drawings, NBS Specifications, BIM Objects, maintenance and installation instructions.

Samples

Call Gradus or build a design board online and get all the samples you need within 24 hours.



Project Management & Installation Service

Experts in contract interior solutions

Gradus is the largest UK manufacturer of Wall Protection products and has been manufacturing contract interior products for over 50 years. Over the last 25 years, Gradus has become the market leader for both the supply and installation of specialist wall protection products.



Why Gradus Contracts?

Gradus has built strong brand values around its product offer of quality, design, service and expertise to ensure peace of mind for all customers. These brand values have been embedded into our team ensuring product installations maintain the same high standards recognised by all Gradus customers.



A full supply and installation package is offered by Gradus that provides peace of mind for customers and clients throughout the design, estimating and installation process on a selection of products:

- > Wall Protection
- > Entrance Matting
- > Lighting
- > Safety & Protection Systems



Project Management and Installation

Projects are managed throughout the UK from survey and specification through to installation and handover.

Gradus offers:

- > An in-house installation team, providing national coverage, which are either NeBosh, IOSH, SMSTS or SSSTS qualified
- > Approved installers with trade specific CSCS cards
- > ISO 9001:2015 and ISO 45001:2018 certification to ensure continuous improvement, customer satisfaction and a safe and healthy working environment
- > We use NIC EIC registered electricians where required
- > Project team holds 18th Edition (BS 7671:2018)
- > All our installation team are - CSCS qualified - SSSTS qualified - UKATA Asbestos & Manual Handling

Specification and Survey

The criteria for product selection and specification to meet performance, costs and standards has never been more essential and Gradus can offer clients and contractors its expertise and knowledge to provide cost effective solutions.

Gradus offers:

- > Nationwide specification sales team
- > Full survey and estimating service with dedicated electronic take-off capabilities
- > Advice to meet the latest guidelines:
 - Approved Document M
 - BS 8300-2:2018
 - HBN 00-10
 - HBN 00-04
- > MAT 05 - designing for robustness
- > Full CAD and design service
- > Value engineering
- > Bespoke design service



Our Commitment to the Planet

Our values guide our actions

In every aspect of our activities, we take responsibility for the environment and pledge to meet our present business needs without compromising our long-term future environment.

Protecting buildings

Wall protection systems prevent damage to buildings caused by everyday wear and tear, as well as accidental impacts. This can extend the lifespan of walls and reduce the frequency of repairs. Lower amounts of repair and maintenance could result in a reduction in operational carbon emissions for many businesses.

Frequent repairs are often time-consuming and require the use of resources such as paint and other materials. Wall protection prevents this, helping to reduce the carbon emissions associated with the repair and maintenance process.



Limit our water consumption

In the interests of resource management, we set up actions to reduce our water consumption. This includes the setting of efficient closed-circuit cooling systems.

Water Usage

Our closed loop water system installed on all our extrusion production lines saves approximately 495,000 litres of water per year.

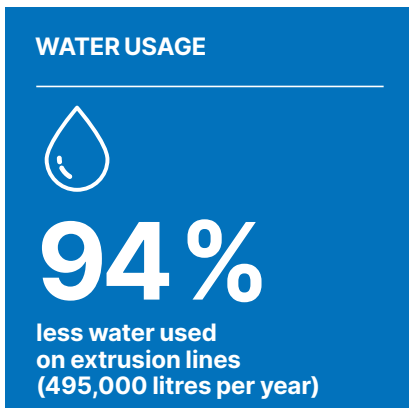



The Benefits of PVC

What is it?

PVC, or Polyvinyl Chloride to give it its full title, is a thermoplastic. It is made up from two starting materials – salt (57%) and natural gas or oil (43%). Salt is one of the world's most abundant resources. Over 50 quadrillion tonnes of salt exist dissolved in the oceans and over 200 billion tonnes are available underground. In addition, PVC uses less fossil fuels than all other commodity plastics.

Safe & Trusted

PVC is an inert, non-toxic polymer and as such is one of the few materials that is trusted for use in the storage of live human blood cells for products such as blood bags and blood tubing. In the event of a fire, PVC is flame retardant due to the high chlorine content. If removed from the fire it will self-extinguish.

Energy Consumption

PVC consumes less non-renewable primary energy resources (e.g. gas & oil) than ALL other commodity plastics including PCs (Polycarbonates), PEs (Polyethylene) and PETGs (Polyethylene Terephthalates Glycol-modified).

Recyclable

PVC can be recycled typically 6-7 times within its lifetime. Gradus wall protection PVC-u components contain up to 100% recycled content and all surplus Gradus rigid PVC waste is granulated and sold on to third parties for use in the manufacture of products such as traffic cones and coat hangers. Start-up scrap is taken for reprocessing to be used in the construction industry e.g. roadways.

2025 GOALS



100%

to retain 100% REACH compliance across all our suppliers



Recycling: Part of our DNA

Reduction in General Waste / Waste Management

All the Gradus waste streams are removed by Registered Waste Carriers. Dry Mixed Recycling (paper, cardboard, polythene, cans etc) collection points have been set up across all sites. This cleaner waste material is diverted from landfill.

Wooden pallet usage has been reduced from 15,215 in 2017 to 10,310 in 2021 which equals to a 32% reduction. A simple but effective initiative of reusing unwanted supplier pallets from our carpet manufacturing facility for customer orders in our Matting department has massively impacted this reduction.

All our non-recyclable waste is diverted from landfill by Biffa Ltd, Alwin Ltd and Elsa Waste Ltd and sent for incineration. Overall Gradus has reduced skip removal by 75% with a focus on recycling rather than landfill.



PVC waste reduction

- > **22%** reduction in overall waste created from production of PVC components or products
- > **1,375 tons** of process waste reused since 2012
- > **10%** increase in processed waste being reused in the extrusion process between 2020 and 2021
- > **151,150 Kgs** of PVC waste recycled into reusable pellets for Gradus production or new 3rd party products such as traffic cones

Aluminium waste reduction

- > **12%** reduction in overall waste created from production of aluminium components or products
- > **254 tons** of aluminium recycled since 2012
- > **14%** increase in aluminium recycled between 2020 and 2021
- > **16%** reduction in contaminated aluminium since 2012 making recycling easier
- > **78%** of aluminium we source contains **100%** recycled content

RECYCLING



Gradus makes every effort to conserve the use of materials and minimise the quantity of waste generated. We maximise the recycling ability of all waste materials that we generate. We also take into consideration the environmental impacts of new product development processes and new products are developed with recyclability as a key factor.

Gerflor[®]
theflooringgroup

GRADUS
A Gerflor company

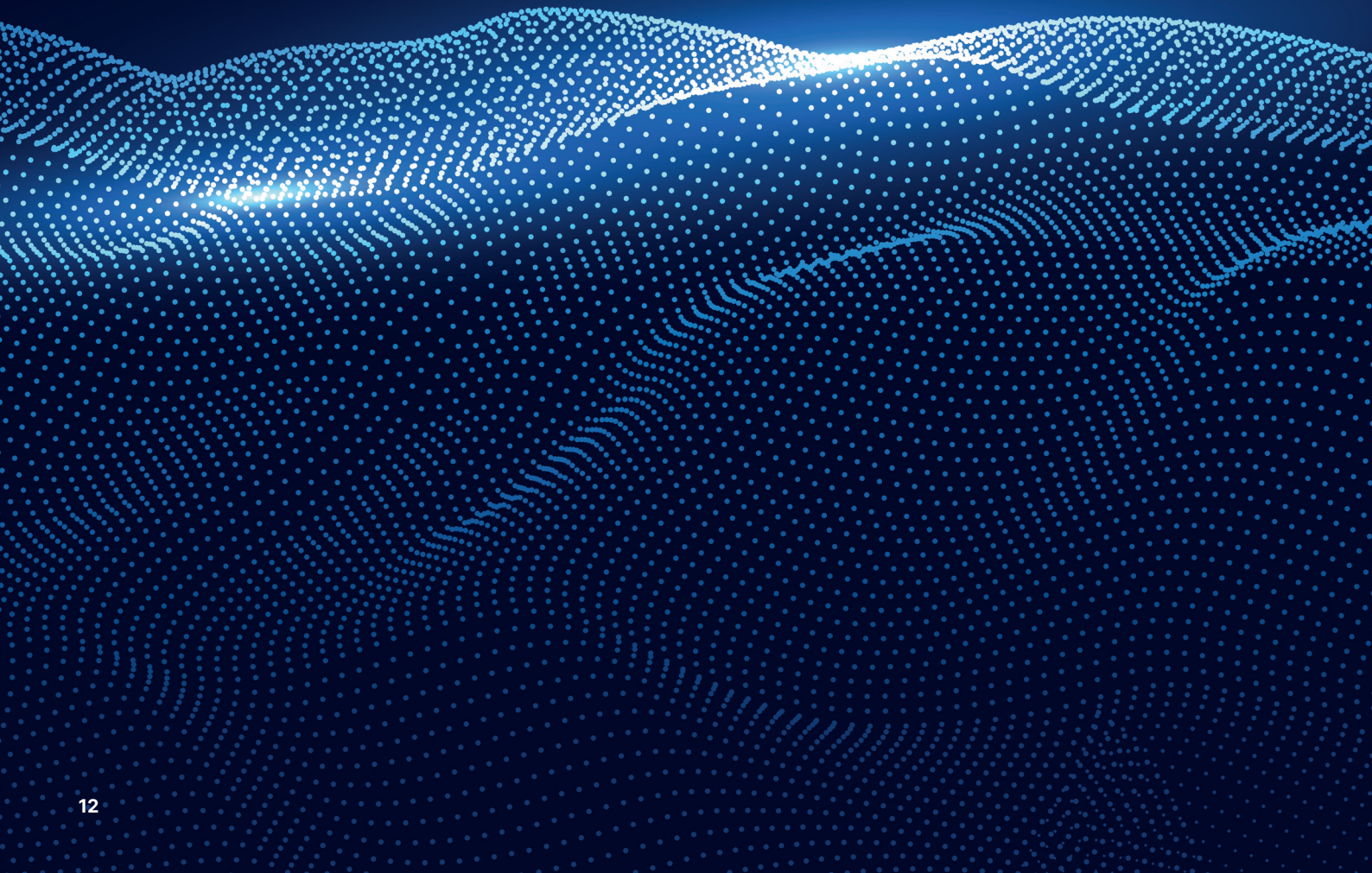

FUNDAMENTALS

A FUSION OF PRODUCTS & VALUES

Gerflor and Gradus offer products which are ideal for use in a wide variety of applications including healthcare, commercial office, education, retail, hospitality & leisure and housing. Products can be combined to provide a complete package that balances performance, aesthetics and cost alongside environmentally responsible manufacturing processes.

A FRESH APPROACH

We believe passionately in providing the customer with the very best in terms of service. Through our combined team we can offer expert advice to help with product selection backed up with extensive UK stocks to ensure our products are delivered on-time, every-time.

A NEW LEVEL
OF INNOVATION,
QUALITY, SERVICE
& TEAMWORK

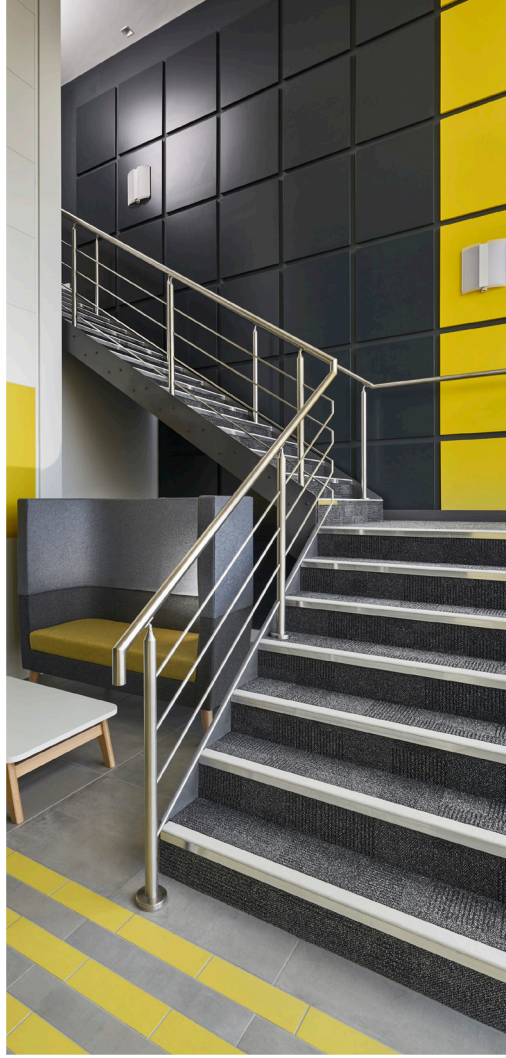

STAIR EDGINGS
FLOOR TRIMS
MATTING
WALL PROTECTION
LIGHTING

NEXT DAY SERVICE
PRODUCT EXPERTISE
WARRANTY
SUSTAINABILITY





CREATION LVT
 TARASAFE
 TARAFLEX
 TECHNICAL TILES
 CARPETS



HOUSING
 RETAIL
 HOSPITALITY
 TRANSPORT



EDUCATION
 HEALTHCARE
 COMMERCIAL OFFICE
 SPORTS

An introduction to wall protection

Why use Gradus wall protection systems?

Wall protection products are designed to protect interior building surfaces from damage caused by the general flow of wheeled and pedestrian traffic.

Specifying wall protection can help to reduce the levels of everyday damage to building interiors, minimise the need for on-going repair and maintenance, reduce lifecycle costs, improve building accessibility and enhance the long-term appearance of building interiors.

Benefits of specifying Gradus wall protection include:

- > Reduced maintenance, repair, and refurbishment costs through the prevention of damage to interiors.
- > Improved aesthetics can be achieved by utilising products in colours and finishes that complement practically any design scheme.
- > All our colours have been measured for Light Reflectance Values to assist with ensuring visual contrast is achieved where necessary.
- > Full supply and installation service is provided through our experienced contracts department.
- > Products are designed to help meet specification guidelines including Building Regulations 2010 - Approved Document M and Approved Document K; BS 8300-2:2018, HBN 00-09 and HBN 00-03 (see page 130 for details).

Typical Causes of Damage



Trolleys



Luggage



Wheelchairs



Beds



Pedestrians



Vehicles



Wall Cladding Systems

Available in a range of sizes, colours and finishes to accommodate specification requirements. Bespoke cutting and design options available. Finishing options include thermoforming, a range of trims, colour matched silicone sealant and weld rod.

See page 44



Wall Guards, Wall Strips & Bed Head Protectors

Wall Guards can be placed at the exact position on the wall that suffers impact or damage to offer direct protection. Wall Strips are a cost effective alternative to wall guards where medium duty protection is required against impact, abrasion and scrapes. Bed Head Protectors are designed to prevent damage to walls and medical equipment from beds or chairs that are frequently moved around.

See page 62



Door Protection

Doors and door frames are vulnerable to damage due to the constant flow of pedestrian and wheeled traffic. Gradus offers a variety of door protection solutions to prevent damage, conceal existing damage and coordinate or contrast with other elements of the building.

See page 114



Corner Guards

Corners are one of the most vulnerable areas of a building and when left exposed are often damaged from everyday wheeled and pedestrian traffic. Gradus corner guards are available in a variety of material types, styles and heights and are ideal for reducing maintenance costs and maintaining interior appearances.

See page 102

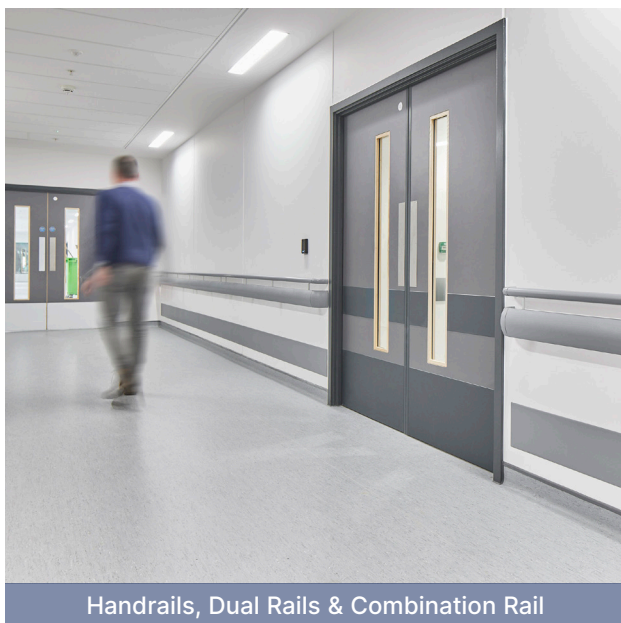

Handrails, Dual Rails & Combination Rail

Gradus handrails are designed to offer pedestrian guidance and support, in addition to a degree of surface protection. Combination rails combine a wall guard and a handrail in a single profile, providing a higher level of protection from wheeled traffic. Dual Rails provide the ideal solution where a handrail and wall guard are required as a combined system, for pedestrian support and impact protection.

See page 80



Floor Mounted Protection

Gradus provide a range of floor rails, posts and bollards to protect building interiors and equipment from potential damage in both front and back-of-house applications. These products provide both a visual and physical barrier and help to minimise damage when impact does occur.

See page 122

Healthcare Solutions

Gradus Wall Protection Systems are both hygienic and safe, suitable for all areas of the healthcare facility.

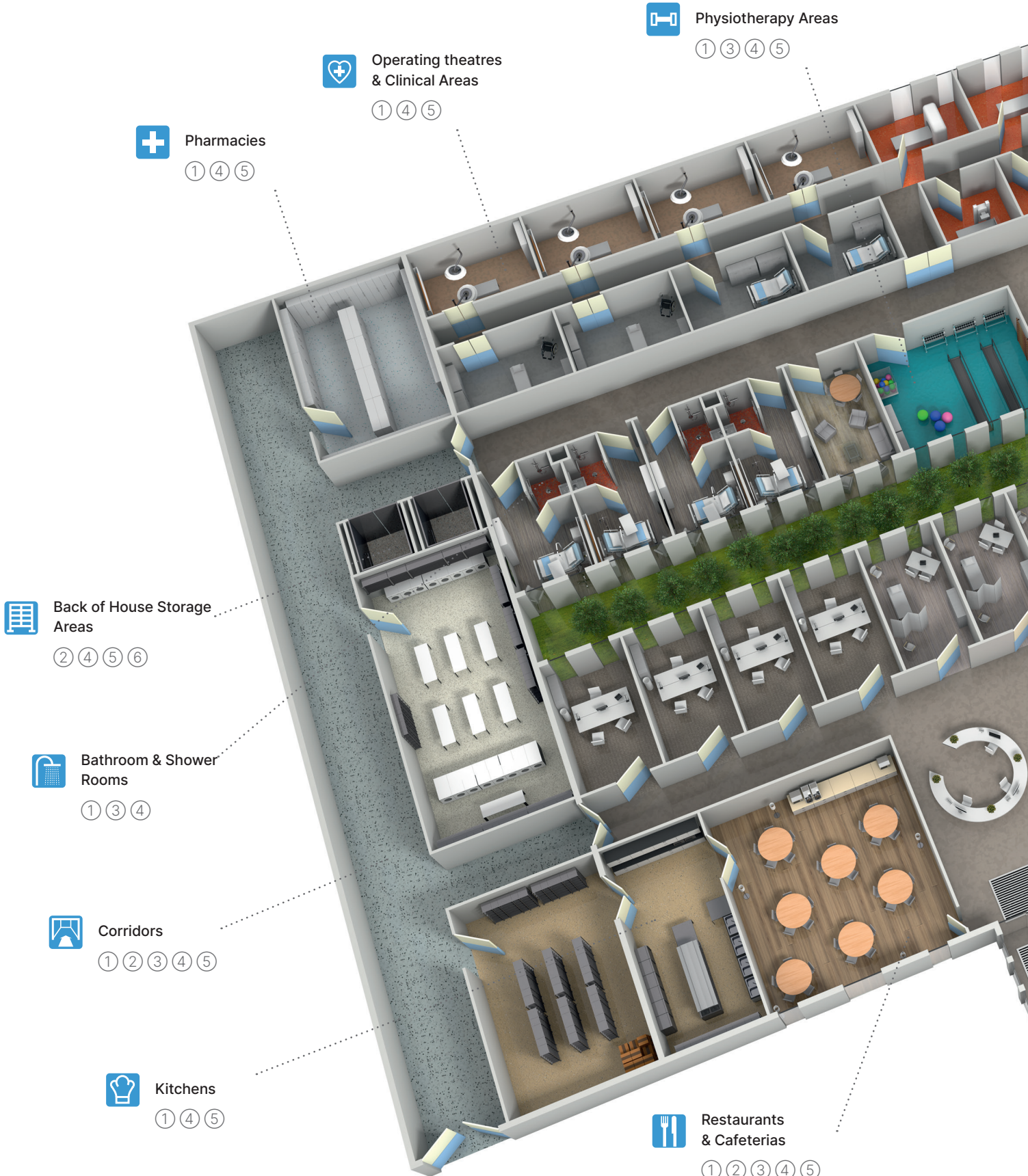



Education Solutions

Gradus Wall Protection Systems are both hygienic and safe, suitable for all areas of education.



Classrooms

① ② ④ ⑤



Kitchens

① ② ③ ④ ⑤



Dining /
Assembly Hall

① ② ③ ④ ⑤



Staff Room

① ② ③ ④ ⑤



Head Teachers Office

① ④ ⑤



Mainframe Room

① ② ④ ⑤



Reception

① ② ③ ④ ⑤



WC Restrooms

① ④ ⑤



Recommended Products

- ① Wall Cladding Systems - page 44
- ② Wall Guards, Wall Strips & Bed Head Protectors - page 62
- ③ Handrails, Dual Rails & Combination Rail - page 80
- ④ Corner Guards - page 102
- ⑤ Door Protection - page 114
- ⑥ Floor Mounted Protection - page 122

Industry Solutions

Gradus Wall Protection Systems are both hygienic and safe, suitable for all areas of the industry facility.

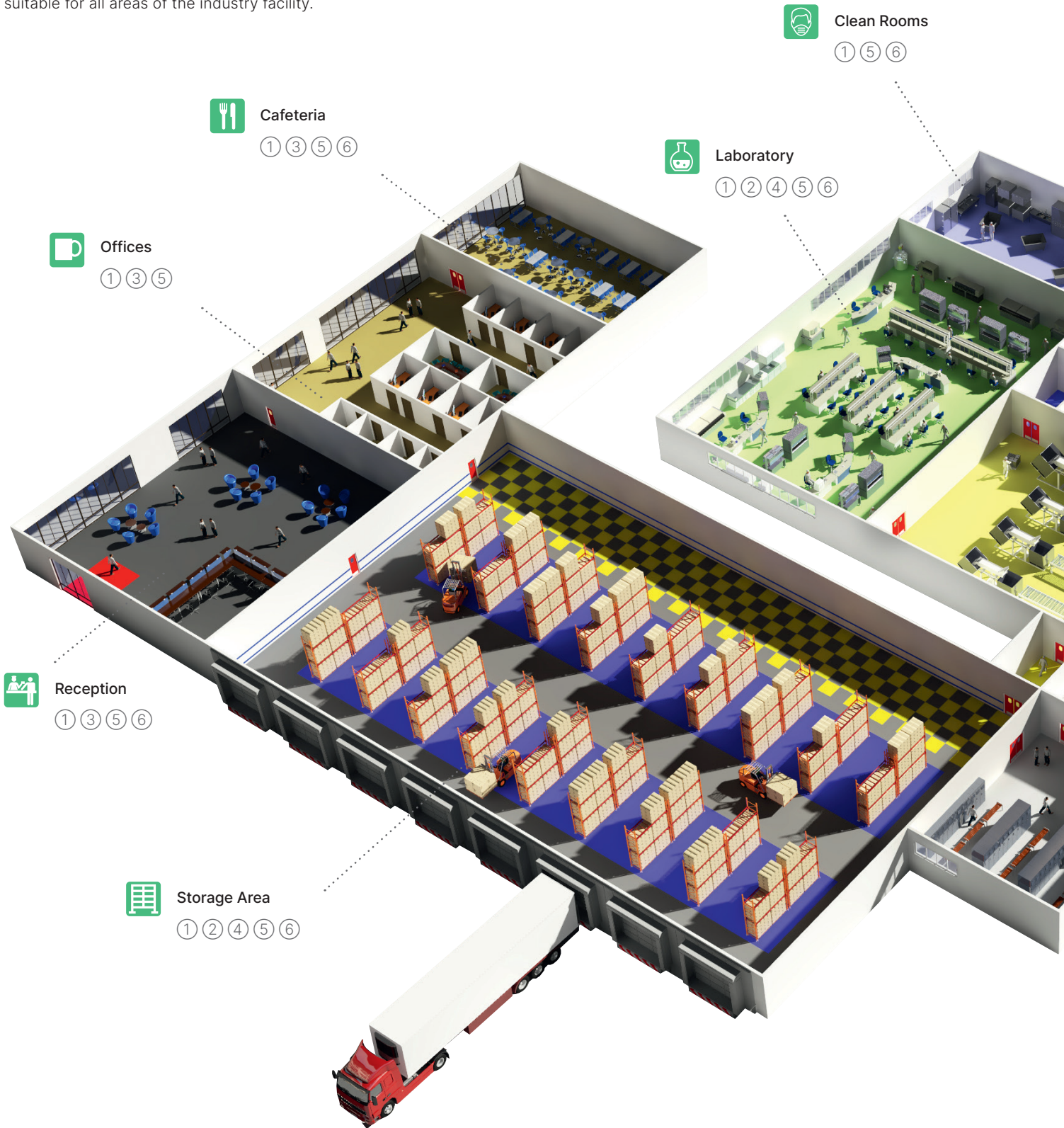

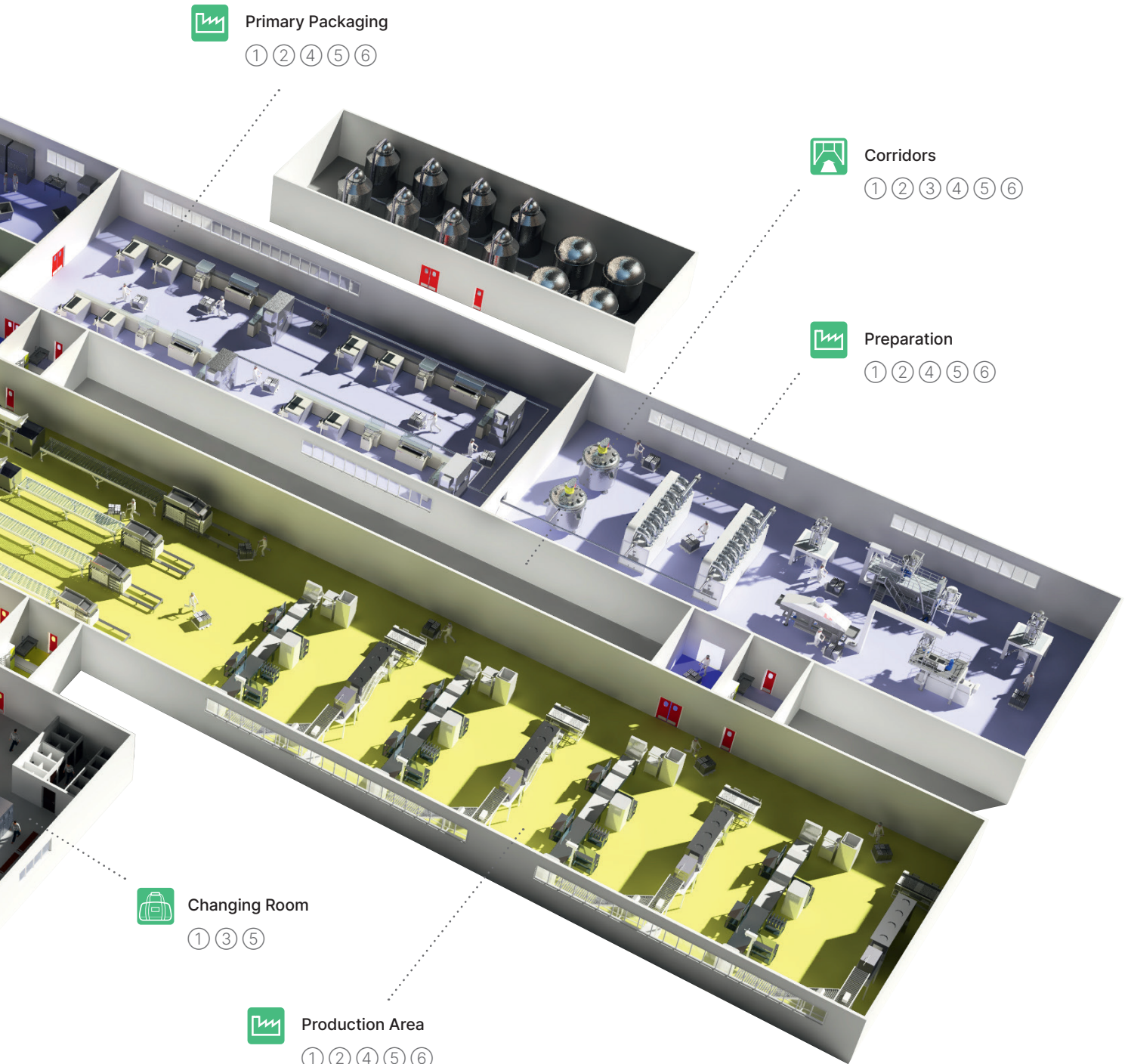

Recommended Products

- ① Wall Cladding Systems - page 44
- ② Wall Guards, Wall Strips & Bed Head Protectors - page 62
- ③ Handrails, Dual Rails & Combination Rail - page 80
- ④ Corner Guards - page 102
- ⑤ Door Protection - page 114
- ⑥ Floor Mounted Protection - page 122

Corridors & Circulation Areas

Corridors and circulation areas are amongst the busiest parts of a building and often have to deal with a heavy flow of both pedestrian and wheeled traffic, which then filters into other parts of the building. This high level of activity often requires a robust protection system in place to protect vulnerable walls and corners from scuffs, scrapes and direct impact damage.



Example: Hospital Corridor

Pedestrian foot traffic including patients, visitors and staff; and wheeled traffic including wheelchairs and other mobility assistance devices, beds, trolleys, laundry carts and mobile equipment are all potential causes of damage in hospital corridors.

- ① Dual Rail - p.92
- ② Wall Guard - p.64
- ③ Door Face Protection - p.116
- ④ High Impact PVC-u Corner Guard - p.104
- ⑤ Stainless Steel Bollard - p.126



Hospital Accommodation

Ward and hospital accommodation is subject to high volumes of activity. Hospital staff are regularly tasked with manoeuvring beds, wheelchairs, mobile medical equipment, service trolleys and other wheeled traffic in relatively confined spaces, increasing the likelihood of impact damage to walls, corners and doors.

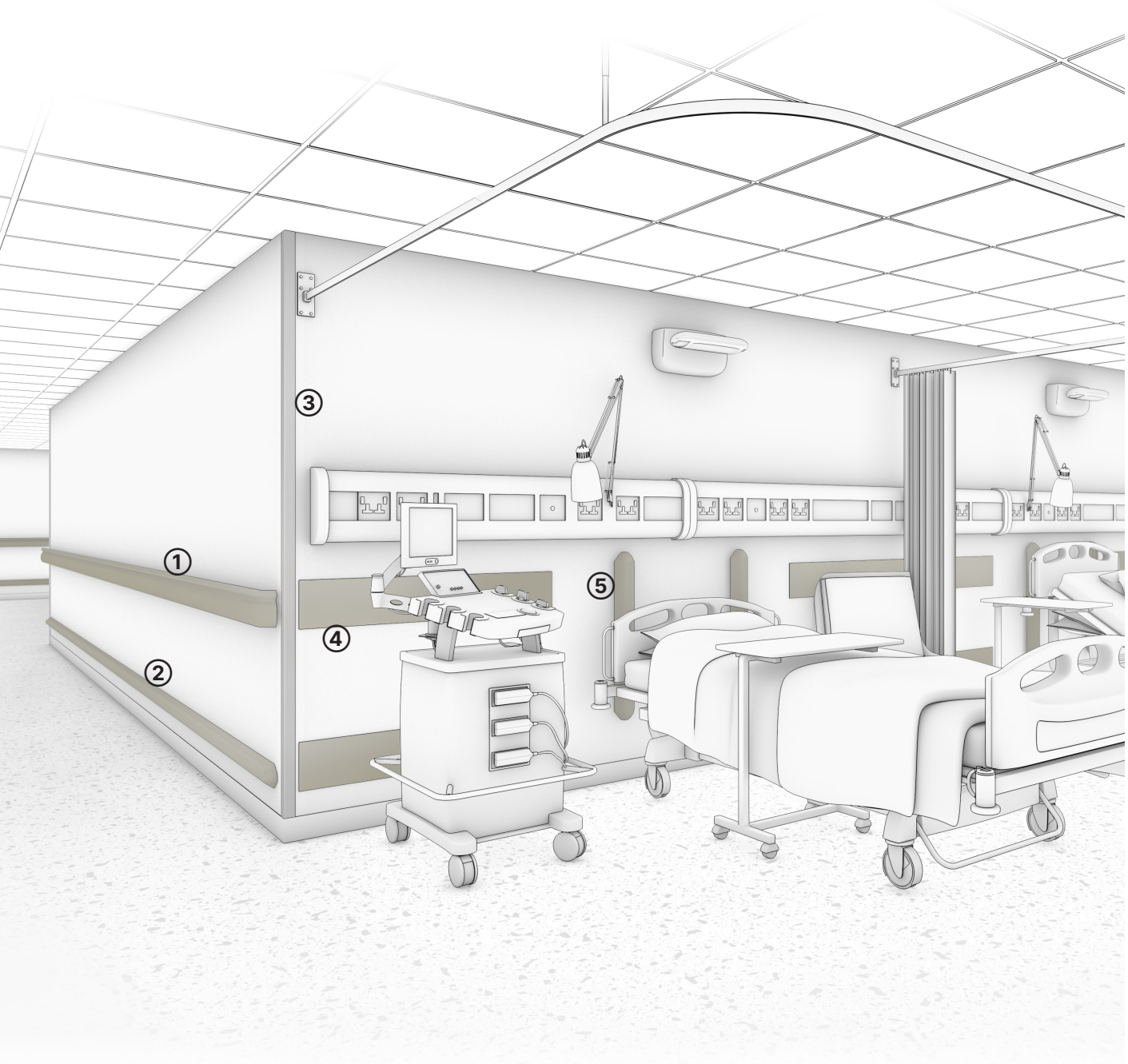

Example: Ward

Hospital patients are regularly wheeled in and out of wards in wheelchairs and mobile beds which risk gouging wall surfaces if a collision were to occur. Other typical causes of damage include mobile medical equipment and service trolleys.

- ① Combination Rail - p.98
- ② Wall Guard - p.64
- ③ High Impact PVC-u Corner Guard - p.104
- ④ Wall Strip - p.70
- ⑤ Bed Head Protectors - p.76



Furness General Hospital, South Lakes Birth Centre

Clinical Areas / Industry

Clinical environments require impervious surfaces that are smooth and easy-to-clean, with a resistance to impact damage. A further consideration when specifying building materials in clinical environments are that they will not be physically affected by cleaning chemicals.

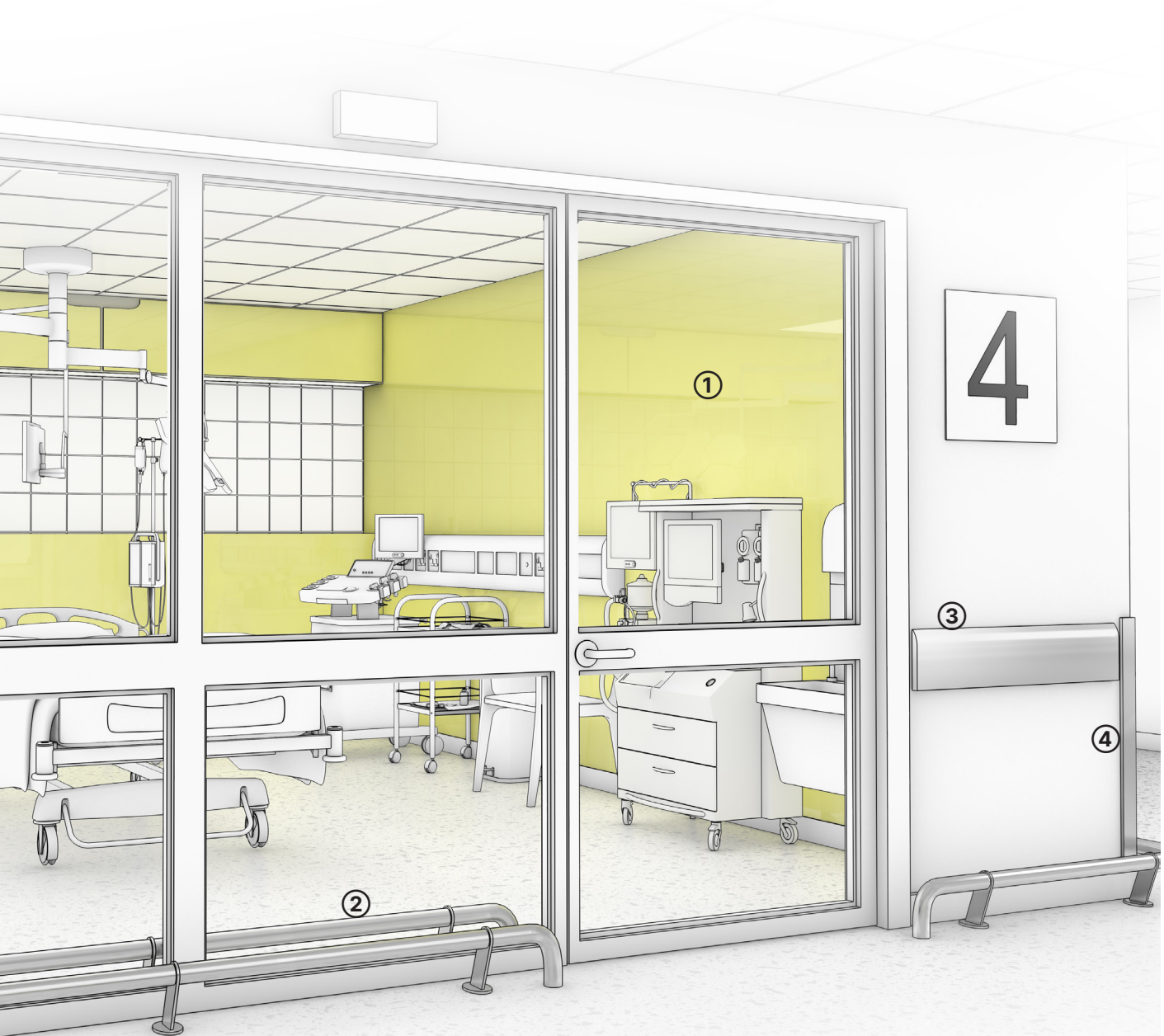

Example: Intensive Care Unit

Strict hygiene standards in intensive healthcare environments require robust building materials that can withstand intensive cleaning. Mobile medical equipment is frequently moved around in ICU areas, increasing the potential for damage.

- ① SureProtect Pure Wall Cladding - p.50
- ② Stainless Steel Floor Rail - p.124
- ③ Stainless Steel Wall Guard - p.72
- ④ Stainless Steel Corner Guard - p.110



Royal Liverpool University Hospital

Commercial Kitchens

Commercial kitchens and food preparation areas require frequent and thorough cleaning to maintain food hygiene standards. Smooth and impervious surfaces are recommended for kitchen walls as an alternative to traditional ceramic tiles and grouting that can harbour bacteria and crack under impact.



Example: Commercial Kitchen

Busy kitchens and canteens are routinely exposed to bacteria and therefore require rigorous cleaning schedules. Movable equipment and catering trolleys are also a potential cause of damage.

- ① SureProtect Pure Wall Cladding - p.50
- ② Stainless Steel Wall Guard - p.72
- ③ Stainless Steel Door Face Protection (pushplate) - p.116
- ④ Stainless Steel Door Face Protection (kickplate) - p.116
- ⑤ Stainless Steel Corner Guard - p.110
- ⑥ Stainless Steel Cladding - p.61



Education

Offices, classrooms, meeting rooms and other working environments are typically required to be practical in design and offer a level of protection from everyday scuffs and scrapes. Wall protection products can be utilised to encourage engagement and improve morale by creating stimulating and vibrant spaces using contemporary design themes.

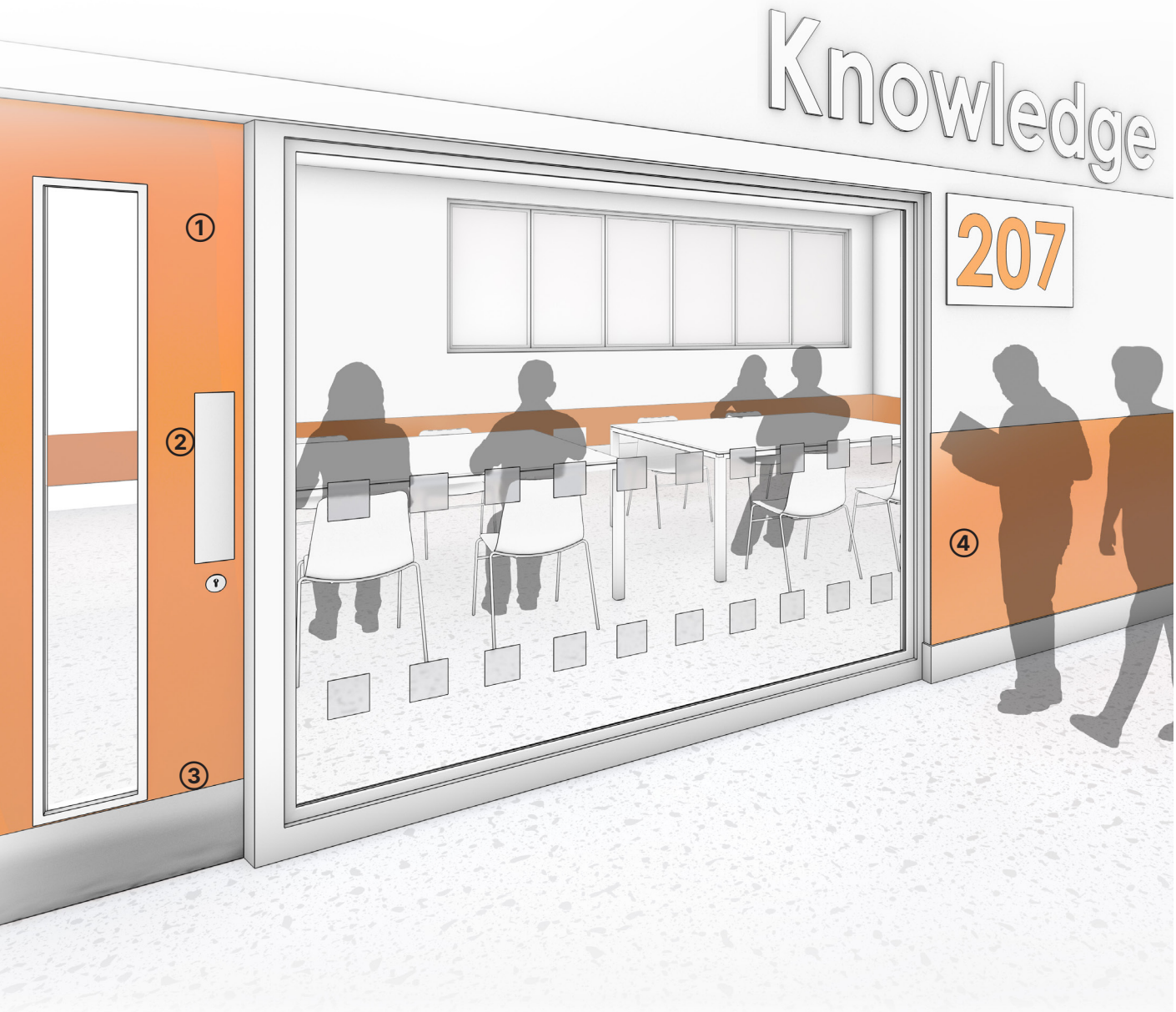

Example: Classroom

Walls and corners are often subject to localised damage caused by students leaning or pushing chairs and tables against walls. Damage is generally limited to scuffs and scrapes from everyday pedestrian traffic and movable objects within the room.

- ① Door Face Protection - p.116
- ② Stainless Steel Door Face Protection (pushplate) - p.116
- ③ Stainless Steel Door Face Protection (kickplate) - p.116
- ④ SureProtect Endure Wall Cladding - p.46



Manufacturing / Industry

Manufacturing plants require high performance Wall Protection systems to protect walls from abrasion and damage caused by wheeled traffic and general wear and tear. High Impact corner guards will also help to protect the most vulnerable parts of the building.



Example: Pharmaceutical Manufacturing

Strict hygiene standards in food & pharmaceutical manufacturing units require robust building materials that can withstand extensive cleaning. Mobile equipment like trolleys are frequently moved around increasing the potential of damage to walls and corners.

- ① SureProtect Pure Wall Cladding - p.50
- ② Stainless Steel Corner Guard - p.110
- ③ Stainless Steel Wall Guard - p.72
- ④ Stainless Steel Bollard - p.126
- ⑤ SureProtect Endure Wall Cladding - p.46
- ⑥ PVC-u Corner Guard - p.106
- ⑦ Stainless Steel Floor Rail - p.124
- ⑧ PVC-u Wall Guard - p.64
- ⑨ SureProtect Endure Door Face Protection - p.116



Back of House

Back-of-house environments including service corridors, loading bays and underground car parks, can be at risk of extensive damage caused by wheeled and vehicular traffic. This level of traffic often requires a robust solution to protect buildings and equipment from damage whilst also helping to improve pedestrian safety.



Example: Service Area

Wheeled traffic such as industrial bins and carts are capable of causing significant damage when accidental collisions occur. Motorised traffic including delivery vans and motorised trolleys are also potential hazards in service areas, where vehicles are operating in confined areas.

- ① Rubber Corner Guard - p.112
- ② Rubber Wall Guard - p.74
- ③ Handrail System (contact Gradus for information)
- ④ Steel Core Protection Post - p.128
- ⑤ Aluminium Chequer Plate - p.60



See through their eyes

A guide to inclusive design for independent living

People with dementia may see the world differently. What may look 'normal' to us could potentially disorientate a person living with dementia, causing distress or even injury. As a result, the buildings we create must be designed with a deep understanding of the ways in which those with dementia will experience them – from the types of materials used to the interplay of different colours and tones. Furthermore, designing to support people living with dementia is also supportive of an ageing population, which has never been more important.

Why is designing for independent living important

The ONS in 2018 highlighted that the UK has an aging population.

Age UK estimate that:

- There are currently 12 million people aged 65 and over
- 5.5 million aged 75+
- 1.6 million aged 85+
- By 2030 it is anticipated that over 21% of the population will be over 65

The number of years of life expected to be spent without a disability or in good health is commonly referred to as disability-free life expectancy or healthy life expectancy (ONS, 2018). The likelihood of being disabled and / or experiencing multiple chronic and complex health conditions increases with age (ONS, 2018).

In general, a person living with dementia tends to be older - age is the biggest risk factor for developing a disease that causes dementia. It is important therefore that designers consider the needs of the older generation and start to plan and design for independent living for today, tomorrow and the future.

We teamed up with the Dementia Services Development Centre (DSDC) at the University of Stirling, an international organisation with more than 30 years' experience in improving the lives of people with dementia through the development of research-led design principles.

As a result of this work, the DSDC has certified an extensive range of our products as suitable for use in buildings used by people living with dementia.



30 Points

People with dementia often have trouble perceiving contrasts between surfaces, leading to trips and falls. For example, it is important that people with dementia can see where the floor ends and the wall begins, so there should be at least 30 points of light reflectance value (LRV) between these two surfaces.



Tonal Contrast Guide

Light Reflective Values

Products can be selected to either visually contrast with surrounding wall surfaces or to blend in with the décor. The type of building, the standards and the type of products being used will influence the selection of colour.

All relevant Gradus Wall Protection colours have been measured to provide Light Reflective Values (LRV's). Colours selected should have an LRV that is 30 points different from the surrounding surface.

Improving access to buildings for all users in line with the Equality Act 2010 is fundamental to ensure that buildings are designed or refurbished to create an inclusive environment. (See Specification Guidelines page 130)

Contrast

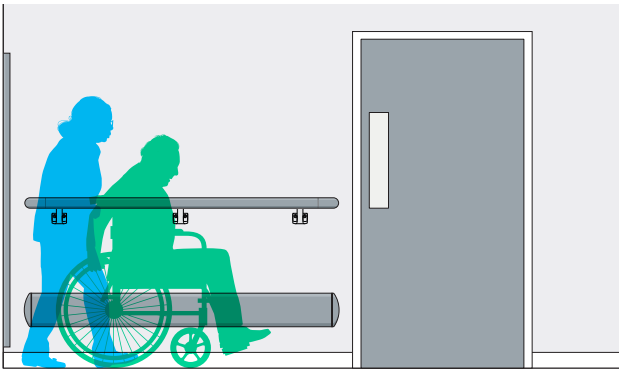

Blend

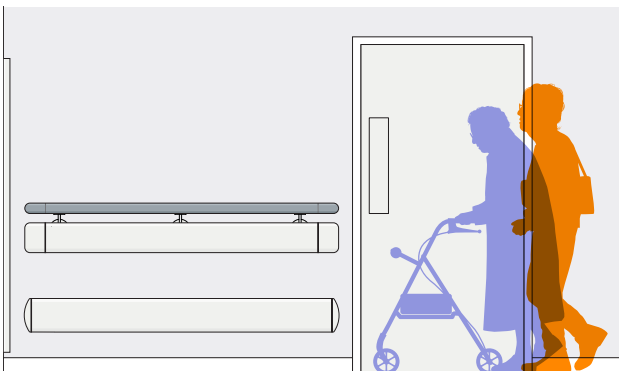

Product Range:

Wall cladding

Wall surfaces should visually contrast with both floor and ceiling colours, so that the size and shape of the room can be accurately interpreted by users with visual impairments.

Wall guards

Contrasting colours can be used as navigation aids or to denote different departments within a building. Blending colours can provide a less institutional feel, reduce visual interference and avoid confusion in people with visual impairments.

Handrails / Combination Rails

Need to be easily identified and located for support and wayfinding. Particularly in environments where there is a higher percentage of users with visual impairments.

Dual-Rail

Allows the handrail element to contrast with the wall, whilst the wall guard element blends with the background.

Corner guards

Contrasting colours can be used to highlight corners and pillars that project into walkways to create safer navigation. Blending colours can provide protection without detracting from the interior décor.

Door & frame protection

Contrasting colours can be used to make doors stand out for access and navigation. Blending colours can be selected to disguise doors that are usually locked or are for staff use only.

Colour Contrast and Dementia Inclusive Environment

Colour and contrast can both be used to enable people with sight loss and dementia to identify different rooms and key features inside and outside of their homes. Good use of colour and contrast can facilitate independent living, for example, by supporting people to find their way around and to use fixtures and facilities unassisted.



The Dementia Services Development Centre at the University of Stirling have undertaken a review of the Gradus Wall Protection products and have rated its design in relation to dementia design principles and its usability within a dementia-inclusive environment.

Colour Availability Chart

Colour	Page	SureProtect Cladding			Handrails, Dual Rail & Combination Rail								Wall Guards & Strips		Corner Guards		BHP		
		SureProtect Pure	SureProtect Endure Kickplates & Rubrails	SureProtect Design	Handrail SHR40P	Handrail SHR40W	Handrail SHR40S	Handrail SSHR42	Handrail THR450	Dual Rail D200P	Dual Rail D200T	Dual Rail D200W	Dual Rail D200S	Combination Rail CHR110, CHR160	WGS200, WGA100	WGS125 WST150, WST200	CGH5090, CGH7590 & CGH75135	CGS2590, CGS5090 & CGS7590	Adjustable-angle
038 POLAR			*																
001 CHALK			*		*				*	*	*	*	*	*	*	*	*	*	*
031 ALUM			*						*	*	*	*	*	*	*	*	*	*	*
032 FLINT			*		*	*	*	*	*	*	*	*	*	*	*	*	*	*	*
004 GRANITE			*		*	*	*	*	*	*	*	*	*	*	*	*	*	*	*
011 PEBBLE			*		*	*	*	*	*	*	*	*	*	*	*	*	*	*	*
002 GRAVEL			*		*	*	*	*	*	*	*	*	*	*	*	*	*	*	*
035 HESSIAN			*		*	*	*	*	*	*	*	*	*	*	*	*	*	*	*
003 CLAY			*		*	*	*	*	*	*	*	*	*	*	*	*	*	*	*
014 CINNAMON			*		*	*	*	*	*	*	*	*	*	*	*	*	*	*	*
009 SIENNA			*		*	*	*	*	*	*	*	*	*	*	*	*	*	*	*
010 BARK			*		*	*	*	*	*	*	*	*	*	*	*	*	*	*	*
005 SHALE			*		*	*	*	*	*	*	*	*	*	*	*	*	*	*	*
006 IVORY			*		*	*	*	*	*	*	*	*	*	*	*	*	*	*	*
007 WICKER			*		*	*	*	*	*	*	*	*	*	*	*	*	*	*	*
008 SAND			*		*	*	*	*	*	*	*	*	*	*	*	*	*	*	*
013 GREIGE			*		*	*	*	*	*	*	*	*	*	*	*	*	*	*	*
033 SLATE			*		*	*	*	*	*	*	*	*	*	*	*	*	*	*	*
036 BLACK			*		*	*	*	*	*	*	*	*	*	*	*	*	*	*	*
021 STRAW			*		*	*	*	*	*	*	*	*	*	*	*	*	*	*	*
043 MIMOSA			*		*	*	*	*	*	*	*	*	*	*	*	*	*	*	*
041 TERRACOTTA			*		*	*	*	*	*	*	*	*	*	*	*	*	*	*	*
028 POPPY			*		*	*	*	*	*	*	*	*	*	*	*	*	*	*	*
034 ROSE QUARTZ			*		*	*	*	*	*	*	*	*	*	*	*	*	*	*	*
040 LYCHEE			*		*	*	*	*	*	*	*	*	*	*	*	*	*	*	*
030 IRIS			*		*	*	*	*	*	*	*	*	*	*	*	*	*	*	*
042 MULBERRY			*		*	*	*	*	*	*	*	*	*	*	*	*	*	*	*
016 GLACIER			*		*	*	*	*	*	*	*	*	*	*	*	*	*	*	*
018 AZURE			*		*	*	*	*	*	*	*	*	*	*	*	*	*	*	*
048 LAGOON			*		*	*	*	*	*	*	*	*	*	*	*	*	*	*	*
020 DENIM			*		*	*	*	*	*	*	*	*	*	*	*	*	*	*	*
024 BAMBOO			*		*	*	*	*	*	*	*	*	*	*	*	*	*	*	*
044 SAGE			*		*	*	*	*	*	*	*	*	*	*	*	*	*	*	*
045 FERN			*		*	*	*	*	*	*	*	*	*	*	*	*	*	*	*
046 INDIGO			*		*	*	*	*	*	*	*	*	*	*	*	*	*	*	*
WHITE		*																	
PLATINUM		*																	
CHAMPAGNE		*																	
PEPPERMINT		*																	
ICEBERG		*																	
DUCK EGG		*																	
PORCELAIN		*																	
PUTTY		*																	
COTTON		*																	
AQUA		*																	
PEARL		*																	
BLUEBERRY		*																	
IRON		*																	
SORBET		*																	
OLIVE		*																	
SAGE		*																	
ONYX		*																	
FUCHSIA		*																	
SPICE		*																	
CHILLI		*																	
PLUM		*																	
060 MAPLE				*		*						*							
071 CHERRY				*		*		*			*								
062 LIGHT OAK				*		*		*			*								
065 STRIPPED PINE				*		*		*			*								
070 WALNUT				*		*		*			*								
068 SMOKY CEDAR				*		*		*			*								
069 BROWN CEDAR				*		*		*			*								
401 ASH								*			*								
402 OAK								*			*								
403 MAPLE								*			*								
406 SAPELE								*			*								
SILVER ANODISED						*													
STAINLESS STEEL							*												

* BHPA100 ONLY

Colour Availability

PVC-u Profiles & SureProtect Endure®

Standard Colours

35 standard colours provide a colour choice to suit virtually any design scheme, from healthcare and education environments through to leisure and commercial office applications. Refer to the colour chart on page 41 for details of specific product availability.

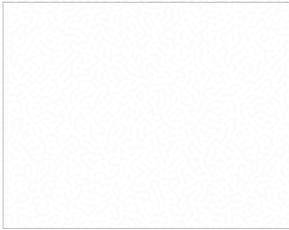

✓ 038 Polar
LRV 80.14 | NCS S 1002-B

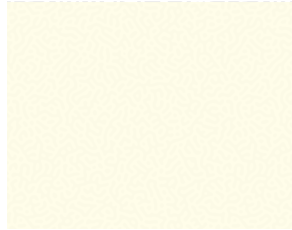

✓ 001 Chalk
LRV 87.51 | NCS S 0500-N

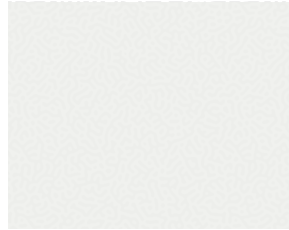

031 Alum
LRV 71.91 | NCS S 1000-N



032 Flint
LRV 43.70 | NCS S 3000-N



004 Granite
LRV 24.07 | NCS S 5502-B

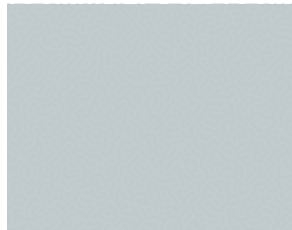

011 Pebble
LRV 59.08 | NCS S 2005-R80B

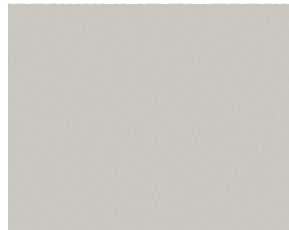

002 Gravel
LRV 53.71 | NCS S 2502-Y

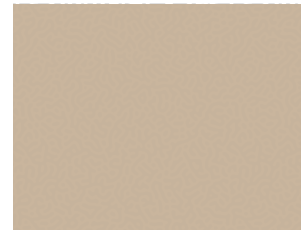

035 Hessian
LRV 35.79 | NCS S 4010-Y30R



✓ 003 Clay
LRV 33.86 | NCS S 4000-N

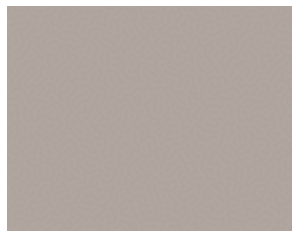

014 Cinnamon
LRV 42.30 | NCS S 3005-Y80R



009 Sienna
LRV 26.67 | NCS S 4010-Y70R / 4005-Y70R



010 Bark
LRV 16.61 | NCS S 6005-Y80R

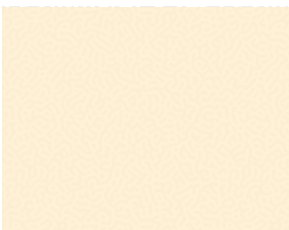

✓ 006 Ivory
LRV 81.98 | NCS S 0505-Y30R

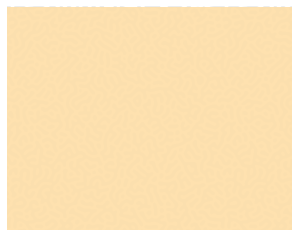

007 Wicker
LRV 70.36 | NCS S 0510-Y30R



008 Sand
LRV 52.26 | NCS S 2010-Y30R



013 Greige
LRV 38.97 | NCS S 3005-Y20R

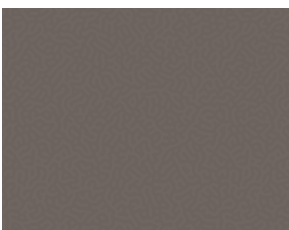

✓ 005 Shale
LRV 17.88 | NCS S 6500-N / 6502-Y

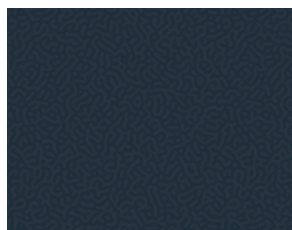

033 Slate
LRV 7.03 | NCS S 8005-R80B

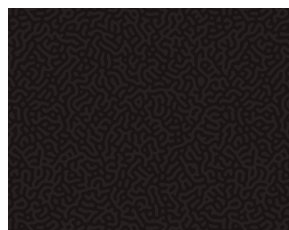

036 Black
LRV 5.08 | NCS S 8502-B

✓ Popular colours stocked in depth

 Textured finish and through coloured to conceal the effects of impact and abrasion

 Visit: www.gradus.com for full details

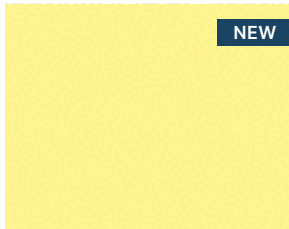

NEW

043 Mimosa

LRV 68.48 | NCS S 0540-G90Y

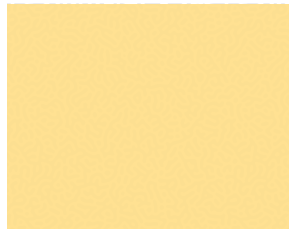

021 Straw

LRV 75.21 | NCS S 0530-Y / 0530-Y10R



NEW

041 Terracotta

LRV 27.04 | NCS S 2060-Y50R



028 Poppy

LRV 16.31 | NCS S 1080-R



034 Rose Quartz

LRV 52.08 | NCS S 1515-R20B

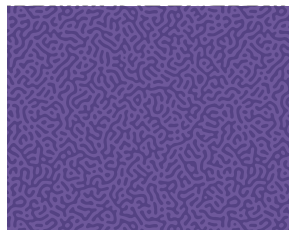

030 Iris

LRV 18.61 | NCS S 4040-R50B



NEW

040 Lychee

LRV 44.83 | NCS S 2030-Y60R



NEW

042 Mulberry

LRV 13.38 | NCS S 4040-R10B



016 Glacier

LRV 59.27 | NCS S 1020-B



018 Azure

LRV 45.14 | NCS S 1040-R90B



NEW

046 Indigo

LRV 10.91 | NCS S 3060-R80B



020 Denim

LRV 16.91 | NCS S 4040-R90B



NEW

048 Lagoon

LRV 48.61 | NCS S 1040-B20G

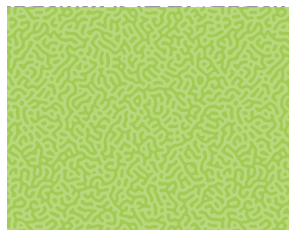

024 Bamboo

LRV 54.74 | NCS S 1040-G50Y



NEW

044 Sage

LRV 39.35 | NCS S 2030-G30Y

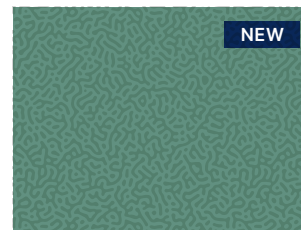

NEW

045 Fern

LRV 18.23 | NCS S 5020-G30Y

Colour Matching

Important note: Due to the limitations of the printing process, colours within this catalogue should not be relied upon for colour matching. An accurate colour match can only be achieved by requesting the relevant product sample(s).

Light Reflectance Values

All Gradus wall protection colours have been measured for Light Reflectance and the Value (LRV) is detailed below each colour (values have been measured using the CIE Y value in accordance with BS 8493:2008+A1:2010). LRVs allow tonal contrast to be achieved between different surfaces to highlight features (e.g. handrails or door furniture), identify hazards or provide wayfinding.

NCS Colour References

Gradus is a member of NCS (Natural Colour System) and utilises the NCS reference codes shown above each colour. For further information visit www.ncscolour.com ©Property of and used under licence from the Scandinavian Colour Institute AB, SCI-Sweden se, Stockholm 2004.

Wall Cladding Systems

Introduction

Wall cladding provides a durable and defensive layer designed to protect large surfaces from scuffs and scrapes, generally caused by pedestrians and movable objects such as chairs, trolleys and tables.

Gradus offers a choice of wall cladding in a range of materials, colour options and finishes to coordinate with most interior design schemes that can be used in a range of applications.





SureProtect Endure Protective Wall Cladding



SureProtect Pure Hygienic Wall Cladding



SureProtect Design Contemporary Wall Cladding



SureProtect Artworx Bespoke Wall Cladding

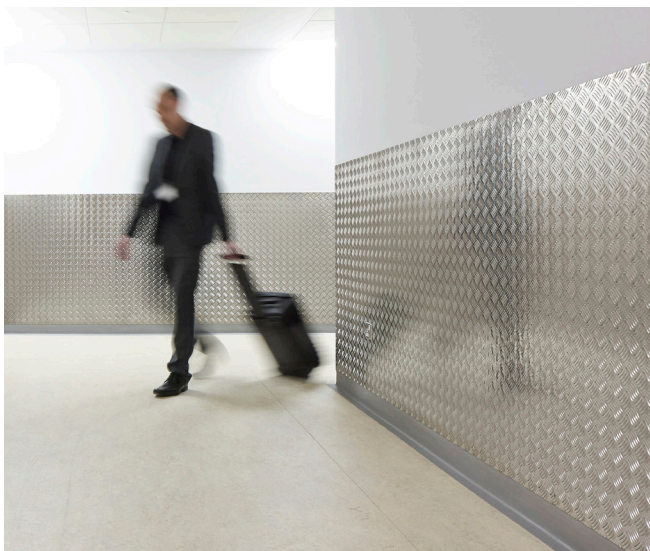

Aluminium Chequer Plate



Stainless Steel Sheet

SureProtect Endure®

Protective Wall Cladding



SureProtect Endure PVC-u sheet is textured to conceal the effects of impact and abrasion. It can be specified as a stand-alone product or be combined with other Gradus wall protection products to create a comprehensive protection system. It helps to reduce the need to repair and re-paint wall surfaces and with minimal maintenance, optimises the appearance retention of the building interior.

Information

- > Supplied in sheet form with the option of finishing trims, silicone sealant and thermoforming
- > Textured PVC-u sheet available in a choice of 35 colours. See page 42
- > Reaction to fire classification
EN 13501-1: Class B Fire/s3 Smoke
See installation instructions for further information

- > Resistance to cleaning chemicals

SPE15N - Sheet dimensions

- > Sheet size: 2440mm x 1220mm x 1.5mm Thickness
- > Bespoke sizes also available, contact Gradus



Leicester Royal Infirmary

Technical Information

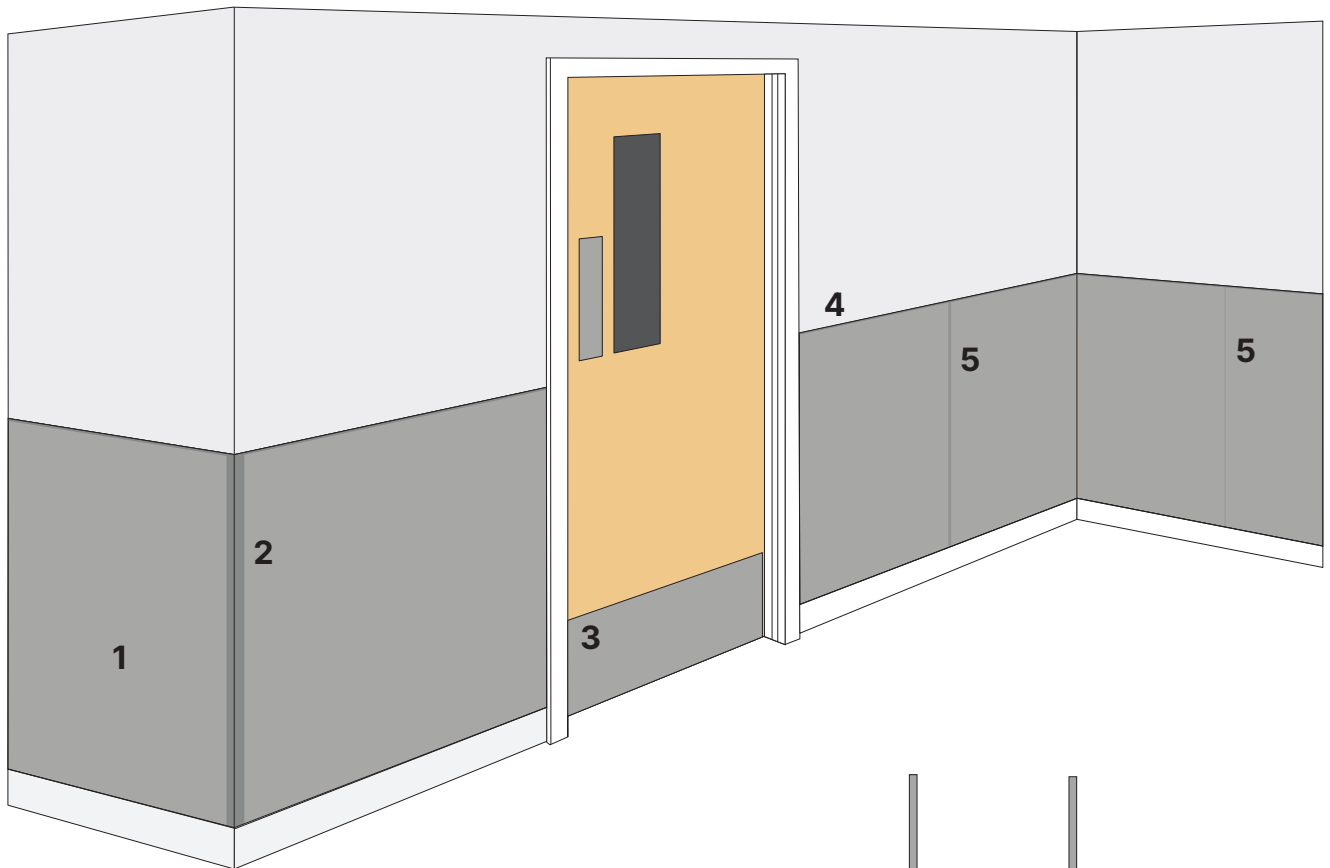

Components

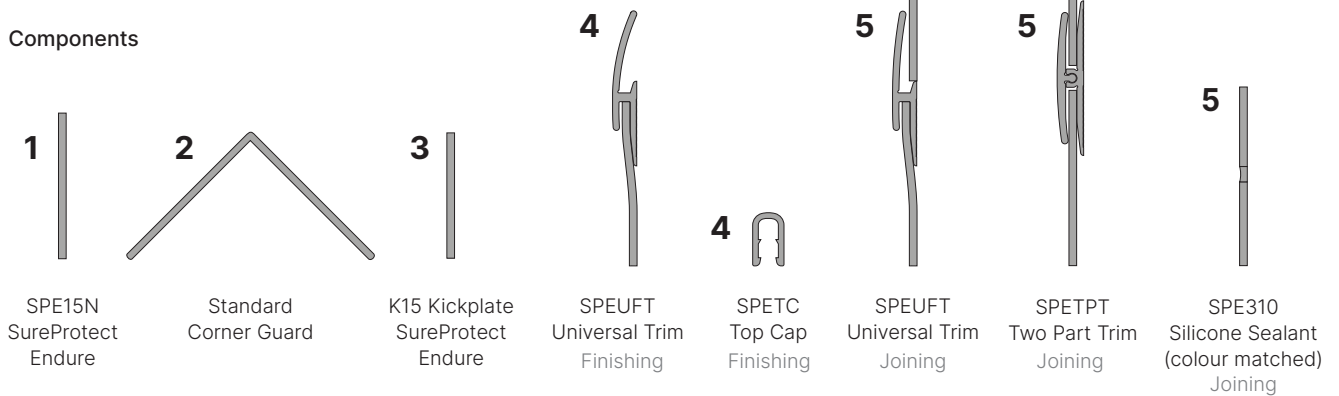

The Dementia Services Development Centre at the University of Stirling have undertaken a review of the Gradus Wall Protection products and have rated its design in relation to dementia design principles and its usability within a dementia-inclusive environment.

SureProtect Endure is rated as Class 1a/b. Finishes within these ratings can be used throughout dementia applications. We recommend a minimum contrast of 30 points LRV for critical surfaces.

For further information contact Gradus Technical Department 01625 428922

Recommended Adhesive - Gradus Grip

- > WGE1 Solvent Free Wall Cladding Adhesive
- > 10 Year Warranty
- > See page 58 for further information



SureProtect Endure®

Cutting and Forming

SureProtect Endure offers excellent flexibility through the versatility of cutting or forming into bespoke designs or profiles, allowing functionality to be combined with aesthetics and offering an endless range of design possibilities.

- > Can be cut to create a variety of designs, from corporate logos in reception areas, themed Rubrails for hotels, and decorative signage.
- > Can be formed into various profiles e.g. 'L' and 'U' shapes
 - 'L' profiles can be used as bespoke corner guards, door edge and door frame protectors
 - 'U' profiles are often used for column protectors or to protect nib end walls

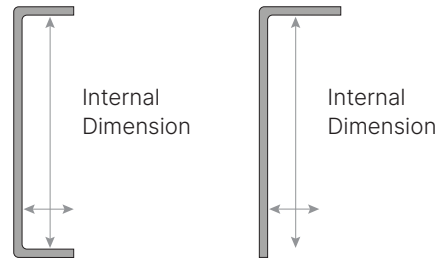

The Grange University Hospital

Rubrails and Kickplates

SureProtect Endure can be cut and shaped into a range of profiles such as Rubrails, Kickplates & Pushplates.

R15 Rubrails

R15 rubrails are available in standard heights from 100mm to 1220mm in 50mm increments. They can be bevelled on the top and bottom edges for a smooth, neat finish on request.

- > R15 Rubrails offer a cost-effective solution for protecting walls where impact and abrasion is likely to occur



R15 Rubrails

K15 Kickplates

K15 Kickplates and Pushplates for doors are available in sizes up to 1220mm x 2440mm and can be bevelled on all edges for a smooth, neat finish on request. They are available with or without pre-applied adhesive.

- > K15 Kickplates & Pushplates – can be applied to new doors by the door manufacturer or surface mounted by a contractor as part of building/refurbishment works



K15 Kickplates



SureProtect Pure[®]

Hygienic Wall Cladding



Specifically developed for areas where cleanliness is a priority, SureProtect Pure creates an impermeable barrier to moisture and bacteria, as well as a durable solution that is resistant to impact damage. The smooth, easy to clean surface is an excellent hygienic alternative to ceramic tiles, removing the need for grout which can harbour bacteria. SureProtect Pure is manufactured from PVC-u material that has been extensively tested to ensure suitability in hygienic environments.

The product adheres to guidance set out in The Health Building Note 00-09 and the Food Standards Agency, making it the perfect solution for healthcare environments and commercial kitchens. It is also ideal for sport and leisure facilities, food manufacturing environments, pharmaceutical laboratories, dentist practices, veterinary surgeries and bathrooms.

Information

- > Smooth PVC-u sheet material in a choice of 21 colours
- > Tested for suitability in a wide range of environments
- > Range of trimming and jointing solutions
- > Reaction to fire classification
EN 13501-1: Class B Fire/s3 Smoke
See installation instructions for further information
- > Complies with ISO 22196:2011 and HBN 00-09

Sheet dimensions

- > 2440mm x 1220mm x 2.5mm Thickness
- > 2500mm x 1220mm x 2.5mm Thickness
- > 3048mm x 1220mm x 2.5mm Thickness
- > Bespoke sizes also available, contact Gradus



Royal Liverpool University Hospital

Colour Availability

Satin Finish



White
LRV 90.87 | NCS S 0300-N

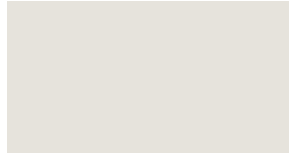

Platinum
LRV 58.81 | NCS S 2002-Y



Champagne
LRV 72.74 | NCS S 1005-Y20R

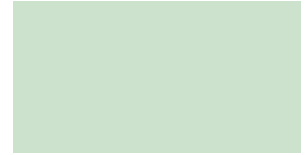

Peppermint
LRV 75.20 | NCS S 0515-G



Iceberg
LRV 65.96 | NCS S 1020-B

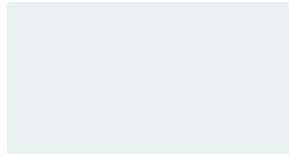

Duckegg
LRV 80.32 | NCS S 0804-B50G



Putty
LRV 41.58 | NCS S 3005-Y50R

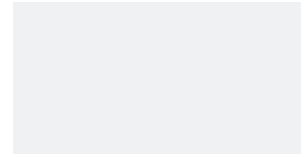

Porcelain
LRV 73.28 | NCS S 0804-R70B

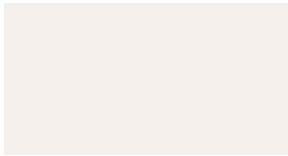

Cotton
LRV 82.91 | NCS S 0502-Y50R



Aqua
LRV 63.26 | NCS S 1015-B20G

Gloss Finish



Pearl
LRV 89.28 | NCS S 0500-N



Sorbet
LRV 64.08 | NCS S 0570-G60Y



Sage
LRV 41.05 | NCS S 3010-G40Y



Olive
LRV 47.52 | NCS S 2030-G60Y



Spice
LRV 19.76 | NCS S 2075-Y60R



Fuchsia
LRV 21.51 | NCS S 1070-R20B



Chilli
LRV 11.83 | NCS S 2070-R



Plum
LRV 9.26 | NCS S 4050-R30B



Blueberry
LRV 34.37 | NCS S 3030-R90B



Iron
LRV 14.63 | NCS S 7000-N

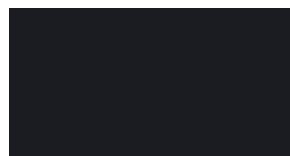

Onyx
LRV 4.96 | NCS S 9000-N

Smooth finish and through coloured to conceal the effects of impact and abrasion



Visit: www.gradus.com for full details

Colour Matching

Important note: Due to the limitations of the printing process, colours within this catalogue should not be relied upon for colour matching. An accurate colour match can only be achieved by requesting the relevant product sample(s).

Light Reflectance Values

All Gradus wall protection colours have been measured for Light Reflectance and the Value (LRV) is detailed below each colour (values have been measured using the CIE Y value in accordance with BS 8493:2008+A1:2010). LRVs allow tonal contrast to be achieved between different surfaces to highlight features (e.g. handrails or door furniture), identify hazards or provide wayfinding.

NCS Colour References

Gradus is a member of NCS (Natural Colour System) and utilises the NCS reference codes shown above each colour. For further information visit www.ncscolour.com ©Property of and used under licence from the Scandinavian Colour Institute AB, SCI-Sweden se, Stockholm 2004.

SureProtect Pure®

Technical Information

SureProtect Pure PVC-u Sheet

Sheet available in the following sizes.

Code	Colour Availability	Length	Width	Thickness
SPP25W/2440	White	2440mm	1220mm	2.5mm
SPP25W/3048	White	3048mm	1220mm	2.5mm
SPP25P/2440	Pastels	2440mm	1220mm	2.5mm
SPP25P/3048	Pastels	3048mm	1220mm	2.5mm
SPP25B/2500	Brights	2500mm	1220mm	2.5mm
SPP25B/3048	Brights	3048mm	1220mm	2.5mm

Joining & Corner options

White (Length 2440mm & 3048mm)

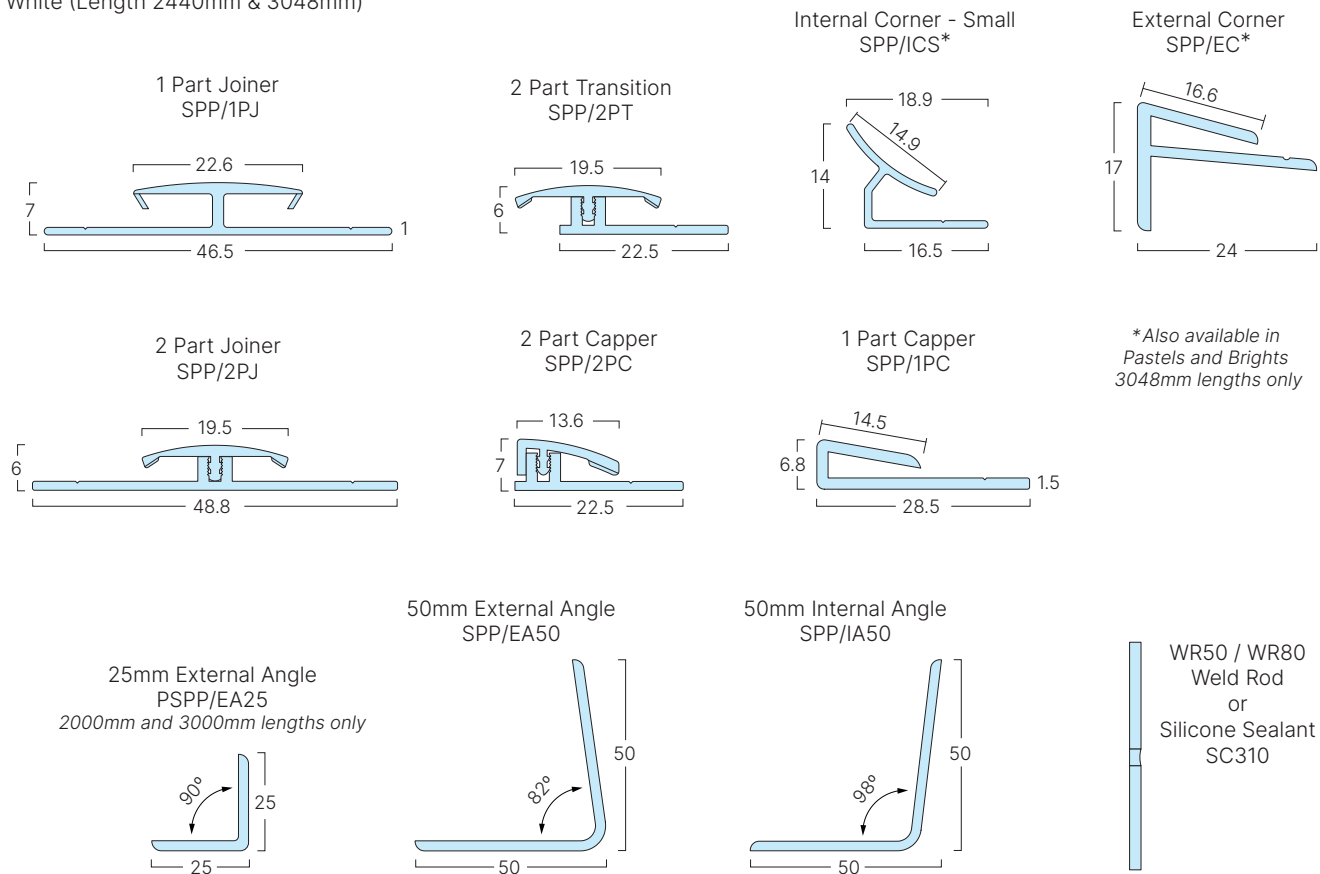

*Also available in Pastels and Brights 3048mm lengths only

Joining options

Pastels and Brights (Length 3050mm)

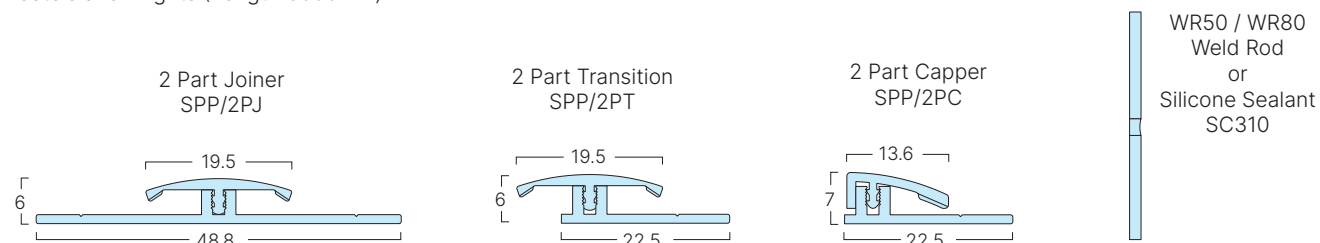

Sealant & Fixings

Silicone Sealant	Weld Rod	Double Sided Tape	Gradus Grip Adhesive
SC310 Available in all colours	WR80 Available for White plus all Pastel colours	NOVAF200A5050	WGP65 2-part polyurethane (6.5kg tub)
	WR50 Available for all Brights plus all Pastel finishes		WGA120 1-part acrylic (12kg tub)

Recommended Adhesive - Gradus Grip

- > WGP65 2-part polyurethane adhesive (6.5kg tub)
- > WGA120 1-part acrylic adhesive (12kg tub)
- > See page 58 for further information



Performance

SureProtect Pure has been extensively tested to the following standards to ensure suitability in hygienic applications.

Test	Description
Bacterial	Tested according to ISO 22196:2011
Food Contact	Meets EU Commission Regulation 10/2011 with regard to food contact
Fire	Reaction to fire classification: EN 13501-1: Class B Fire/s3 Smoke See installation instructions for further information
Impact	Tested to BS EN 438-2 that comparatively measures the impact absorption of SureProtect Pure against standard ceramic tile. The test demonstrates that SureProtect Pure PVC-u sheet can withstand significantly higher impact without damage occurring. Tested to ISO 6603-1:2000 Determination of puncture test.
Maximum temperature should not exceed temperatures of 60°C	

SureProtect Design®

Contemporary Wall Cladding

Modern and stylish in appearance, SureProtect Design elevates building interiors whilst still offering excellent surface protection. Ideal for applications where aesthetics is important such as reception areas, leisure facilities, hotel lobbies, retirement homes and university campuses.

Information

- > Supplied in sheet form with the option of silicone sealant and thermoforming
- > Reaction to fire classification
EN 13501-1: Class B Fire/s3 Smoke
See installation instructions for further information

Sheet dimensions

- > Sheet sizes: 3000mm x 1300mm x 2mm Thickness
- > Bespoke sizes also available, contact Gradus



Colour Availability

SureProtect Design Finishes

These contemporary finishes help to create modern interiors and are an ideal choice in environments such as hospitality, leisure and commercial office.

Woods - SPD20W



060 Maple
LRV 50.0 | NCS S 2020-Y30R



062 Light Oak
LRV 35.4 | NCS S 3020-Y30R



071 Cherry
LRV 26.39 | NCS S 4020-Y30R



070 Walnut
LRV 12.06 | NCS S 6010-Y90R



065 Stripped Pine
LRV 37.0 | NCS S 4005-Y20R



069 Brown Cedar
LRV 18.4 | NCS S 6005-Y50R
* Not available for handrails



068 Smoky Cedar
LRV 10.5 | NCS S 7502-B
* Not available for handrails



The Dementia Services Development Centre at the University of Stirling have undertaken a review of the Gradus Wall Protection products and have rated its design in relation to dementia design principles and its usability within a dementia-inclusive environment.

SureProtect Design wood effects are rated as Class 1a/b*. Finishes within these ratings can be used throughout dementia applications. We recommend a minimum contrast of 30 points LRV for critical surfaces.

* except for 071 Cherry which is rated 2.

For further information contact Gradus Technical Department 01625 428922

Recommended Adhesive - Gradus Grip

- > WGP65 Solvent Free Wall Cladding Adhesive
- > 2-part polyurethane adhesive (6.5kg tub)
- > See page 58 for further information

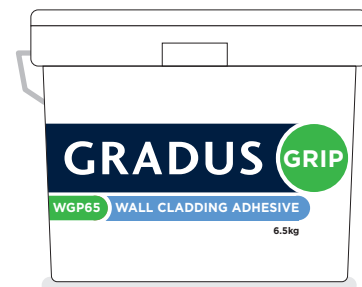

Colour Matching

Important note: Due to the limitations of the printing process, colours within this catalogue should not be relied upon for colour matching. An accurate colour match can only be achieved by requesting the relevant product sample(s).

Light Reflectance Values

All Gradus wall protection colours have been measured for Light Reflectance and the Value (LRV) is detailed below each colour (values have been measured using the CIE Y value in accordance with BS 8493:2008+A1:2010). LRVs allow tonal contrast to be achieved between different surfaces to highlight features (e.g. handrails or door furniture), identify hazards or provide wayfinding.

NCS Colour References

Gradus is a member of NCS (Natural Colour System) and utilises the NCS reference codes shown above each colour. For further information visit www.ncscolour.com @Property of and used under licence from the Scandinavian Colour Institute AB, SCI-Sweden se, Stockholm 2004.

SureProtect Artworx™

Bespoke Wall Cladding

Enhance your building interiors with SureProtect Artworx to help you achieve a healthier more aesthetically pleasing environment. From operating theatres, wayfinding and signage in corridors, welcoming reception areas, calming office environments to bold company logos the design possibilities are endless.



Technical Information

Information

- > Gradus can provide a bespoke cladding solution by digitally printing your photograph/graphic onto a durable sheet
- > Prints can be applied to multiple sheets as a continuous image

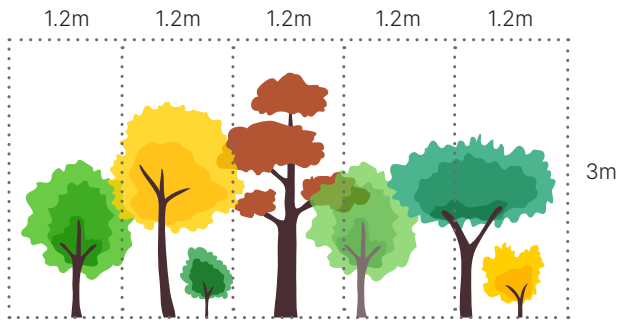

Printing requirements

- > Accepted file formats: PDF vector, Adobe Illustrator vector (typically for drawings) or JPEG, TIFF or any type of image. In this case, resolution must be at least 600dpi at 1:10 scale (typically for pictures)
- > Provide details of finished trimmed size in mm (width x height)
- > Files must be provided in RGB or CMYK, Pantone colours should be specified
- > Photos or graphics supplied via "image libraries" must show copyright traceability and proof of purchase, always buy the largest choice of size.

Typical examples



Gradus Grip

Wall Cladding Adhesive

Introducing Gradus Grip, a selection of specialised wall cladding adhesives meticulously developed and rigorously tested to work with SureProtect. Our exclusive range of adhesives ensures quick and effortless application, guaranteeing both time and cost savings.



GRADUS GRIP

WALL CLADDING ADHESIVE

Technical Information

Gradus Grip WGE1

WGE1 is a medium open-time flexible adhesive with excellent grab characteristics that make it suitable for bonding SureProtect Endure Wall Cladding to suitable substrates. WGE1 is a 1-part reactive adhesive which relies upon atmospheric moisture to cure. For use in internal environments.



Key Benefits:

- > Specifically developed for:
SureProtect Endure PVC-u Sheets
- > WGE1 1-part reactive adhesive (1kg / 650ml)
- > 10 year Warranty
- > Solvent Free
- > EC1 certified
- > Quick and easy to install via the use of a cordless caulk gun

Gradus Grip WGP65

WGP65 is a 2-part polyurethane (PU) adhesive consisting of an Adhesive Base (Part A) and a Curing Agent (Part B), which when mixed & applied produces a fast permanent medium for bonding SureProtect Pure and SureProtect Design Wall Cladding to suitable substrates. For use in internal environments.



Key Benefits:

- > For use with:
SureProtect Pure PVC-u Sheets
SureProtect Design PVC-u Sheets
- > WGP65 2-part polyurethane adhesive (6.5kg tub)
- > Solvent Free
- > EC1 certified
- > Quick and easy ready to mix kit

Gradus Grip WGA120

WGA120 is a 1-part, room temperature curing pressure sensitive Acrylic Adhesive. When pressed into a thin film between the SureProtect Pure Wall Protection Cladding and the substrate surfaces it gives a strong initial tack and a resultant high strength bond. For use in internal environments.



Key Benefits:

- > For use with:
SureProtect Pure PVC-u Sheets
- > WGA120 1-part acrylic adhesive (12kg tub)
- > Solvent Free
- > EC1 certified

Aluminium Chequer Plate

Aluminium chequer plate wall and door panels are strong and durable, ideal for use in areas subject to frequent, heavy wheeled traffic e.g. service corridors, loading areas and car parks.

Key Benefits

- > Panels are light-weight, easy to install and keep clean
- > Reduce maintenance costs by eliminating the need to repair and repaint wall surfaces
- > The embossed chequer pattern conceals the effects of any surface damage caused by wheeled traffic
- > Suitable for both interior and exterior environments
- > Supplied undrilled
- > Note: an exact pattern match cannot be guaranteed
- > Corner guards also available page 110

Sheet dimensions

NEW

- > CPA1/2500/1250
Sheet sizes: 2500mm x 1250mm x 1mm Thickness
- > CPA2/2500/1250
Sheet sizes: 2500mm x 1250mm x 2mm Thickness

Bespoke options

- > Cutting, drilling and custom fabrications



Stainless Steel Sheet

Stainless steel is a robust, durable, heat resistant hygienic material ideally suited for clinical areas, splashbacks and areas exposed to heat.

Key Benefits

- > 304 grade Stainless Steel with Satin finish (other grades available)
- > Robust, durable hygienic material
- > Suitable for Hygienic environments e.g. food preparation, areas and laboratories
- > Cut to individual size requirements
- > Suitable for interior applications
- > Corner Guards also available see page 110

Sheet dimensions

- > K130/SPEC
Sheet sizes: 2500mm x 1250mm x 1.5mm Thickness

Bespoke options

- > Cut to individual size requirements



Wall Guards, Wall Strips & Bed Head Protectors

Introduction

Wall Guards can be placed at the exact position on the wall that suffers impact or damage to offer direct protection. Wall Strips are a cost effective alternative to wall guards where medium duty protection is required against impact, abrasion and scrapes.

Bed Head Protectors are designed to prevent damage to walls and medical equipment from beds or chairs that are frequently moved around.



Allam Building, University of Hull



WGS200 and WGA100 Wall Guards



WGS125 Wall Guard



Wall Strips



Stainless Steel Wall Guard

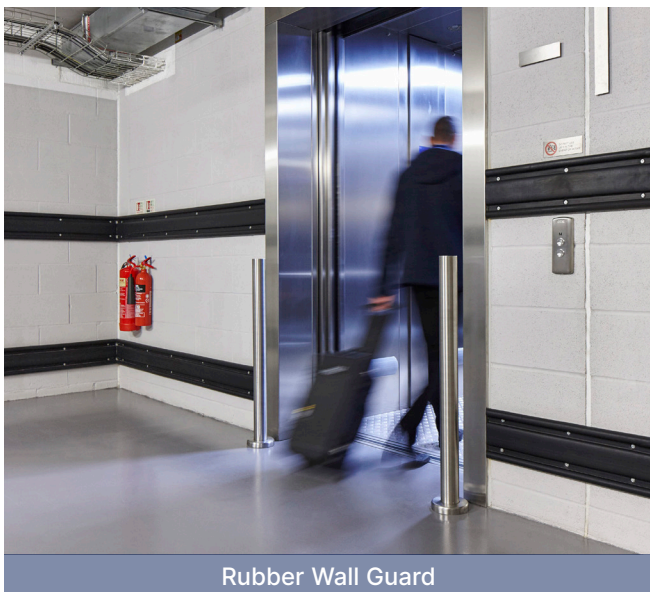

Rubber Wall Guard



Bed Head Protectors

WGS200 Wall Guard

Features

- > Modular system comprising PVC-u covers, aluminium or PVC-u retainers and PVC-u accessories
- > Replaceable, through coloured, easy-to-clean covers - textured to conceal the effects of impact and abrasion
- > Features an internal bumper for additional strength and to absorb and dissipate impact
- > Design ensures a tight fit to wall – minimal dust/dirt trap
- > Reveals provide neat joints and are made from a naturally bactericidal polymer that inhibits the growth of bacteria

Information

- > Supplied in 4.0m lengths
- > Replacement components available to purchase
- > Complementary corner guards available page 102
- > 33 colour options see page 42

Components

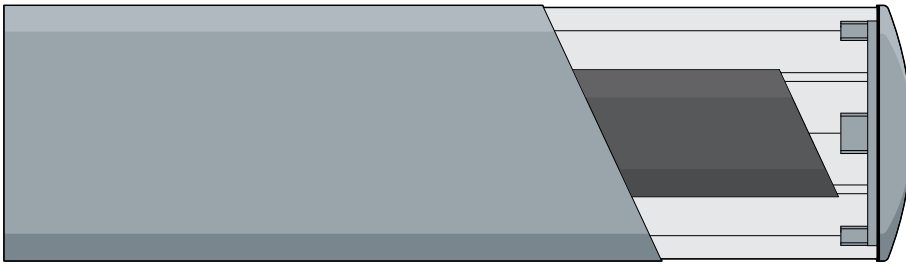

WGS200C
continuous aluminium retainer provides rigid support and is ideal for weaker substrates

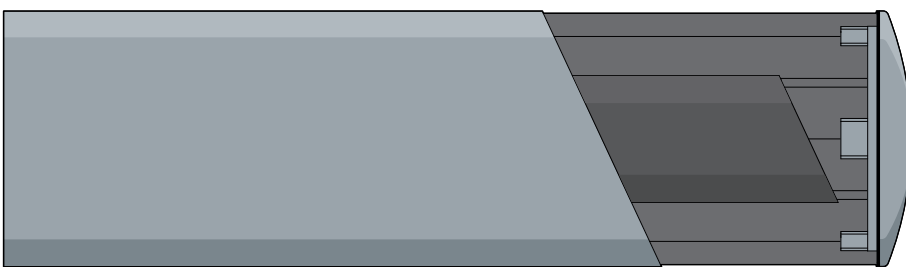
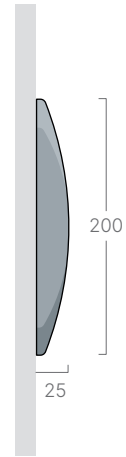

NEW
WGS200P
continuous PVC-u retainer is suitable for gently undulating substrates, made with up to 100% recycled material

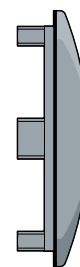

WGS2001
universal end cap
(including reveal)



Visit: www.gradus.com
for full details



Dimensions shown are nominal
Illustrations are in mm



100%
Recyclable



NBS Source
PARTNER



Allam Building, University of Hull

WGS125 Wall Guard

Features

- > Modular system comprising PVC-u covers, aluminium or PVC-u retainers and PVC-u accessories
- > Replaceable, through coloured, easy-to-clean covers - textured to conceal the effects of impact and abrasion
- > Features an internal bumper for additional strength and to absorb and dissipate impact
- > Design ensures a tight fit to wall – minimal dust/dirt trap
- > Reveals provide neat joints and are made from a naturally bactericidal polymer that inhibits the growth of bacteria

Information

- > Supplied in 4.0m lengths
- > Replacement components available to purchase
- > Complementary corner guards available page 102
- > 32 colour options see page 42

Components



WGS125C
continuous aluminium retainer provides rigid support and is ideal for weaker substrates

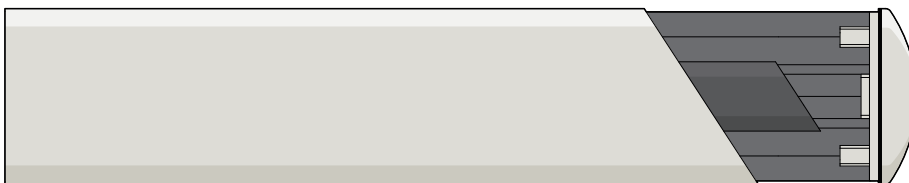
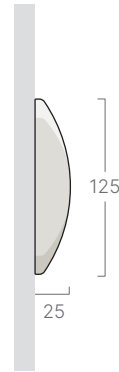

NEW
WGS125P
continuous PVC-u retainer is suitable for gently undulating substrates, made with up to 100% recycled material

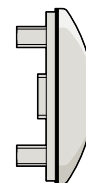

WGS1251
universal end cap
(including reveal)



Visit: www.gradus.com
for full details



Dimensions shown are nominal
Illustrations are in mm



100%
Recyclable



NBS Source
PARTNER



Brighton 3Ts - Royal Sussex County Hospital

WGA100 Wall Guard

Features

- > Modular system comprising PVC-u covers, aluminium retainers and PVC-u accessories
- > Replaceable, through coloured, easy-to-clean covers - textured to conceal the effects of impact and abrasion
- > Angular design provides an extended depth of protection against damage
- > Reveals provide neat joints and are made from a naturally bactericidal polymer that inhibits the growth of bacteria

Information

- > Supplied in 4.0m lengths
- > Replacement components available to purchase
- > Complementary corner guards available page 102
- > 33 colour options see page 42

Components



WGA100
continuous aluminium retainer

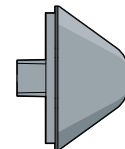
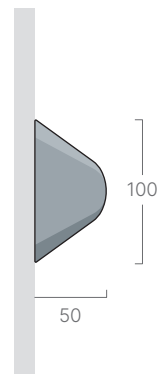

WGA1001
universal end cap
(including reveal)



Allam Building, University of Hull

WST150 & WST200 Wall Strips

Features

- > Scratch and stain resistant PVC-u is through coloured and textured to conceal the effects of impact and abrasion
- > Can be used along the entire length of a wall or cut down into kickplates or pushplates
- > Ideal for protecting walls against scuffs, scratches and abrasion caused by chairs, tables, trolleys and other moveable objects
- > Available with tape for quick and easy installation, or without tape for installing with a suitable adhesive

Information

- > Supplied in 4.0m lengths
- > 32 colour options see page 42

Components

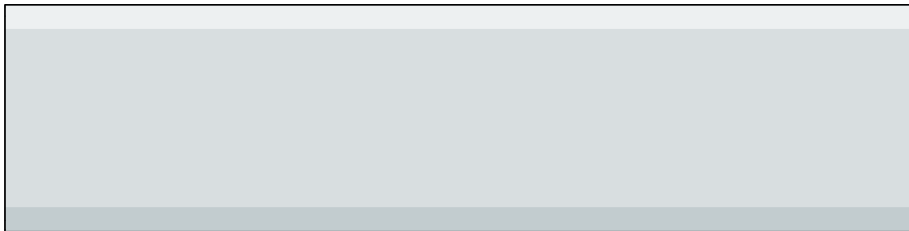

WST150N
150mm (h) no tape

WST150T
150mm (h) with tape

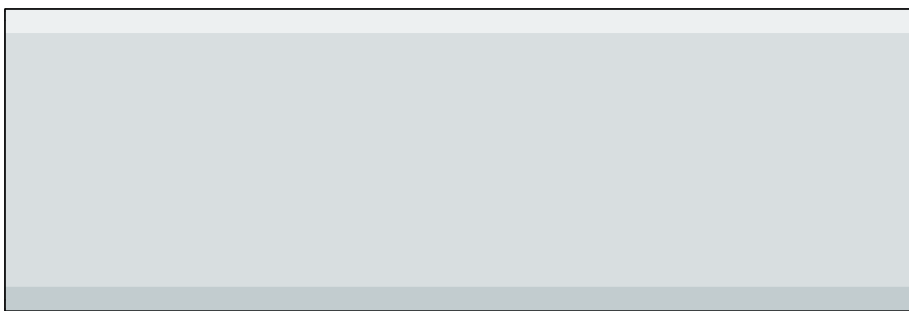
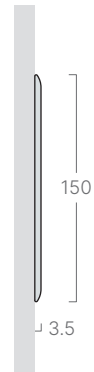

WST200N
200mm (h) no tape

WST200T
200mm (h) with tape

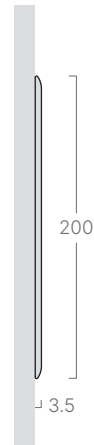

Visit: www.gradus.com
for full details



Dimensions shown are nominal
Illustrations are in mm



100%
Recyclable



NBS Source
PARTNER

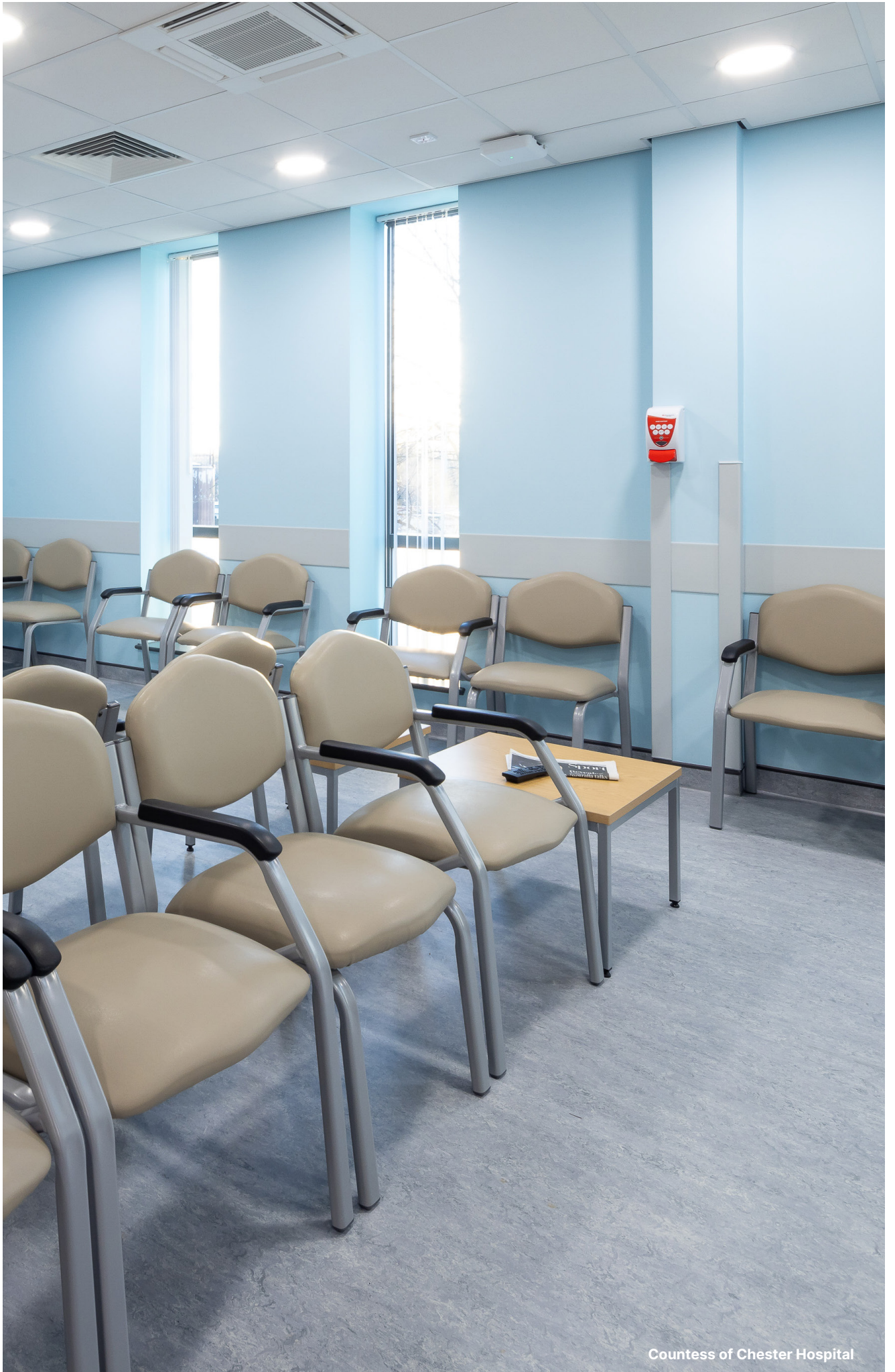

Countess of Chester Hospital

SSWG Stainless Steel Wall Guards

Features

- > Continuous stainless steel covers with aluminium fixing retainers
- > 3 profile designs intended for interior use
- > Hygienic nature of stainless steel makes the wall guards ideal for use in environments such as food and pharmaceutical preparation and manufacturing facilities
- > End caps are formed during manufacture

Information

- > Colour: Satin finish
- > Size: Supplied cut to size to a maximum length of 2.95m (longer runs should be butt jointed on-site)
- > Material: 304 grade stainless steel
- > Complementary corner guards available page 110

Components

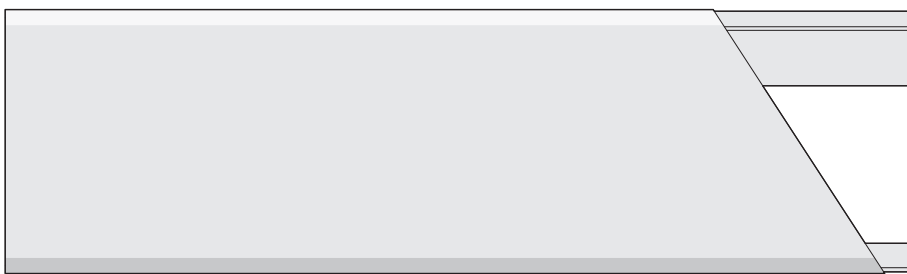

SSWGA1
25 (d) x 73 (h)

SSWGA2
25 (d) x 101 (h)

SSWGA3
25 (d) x 152 (h)

SSWGA4
25 (d) x 195 (h)

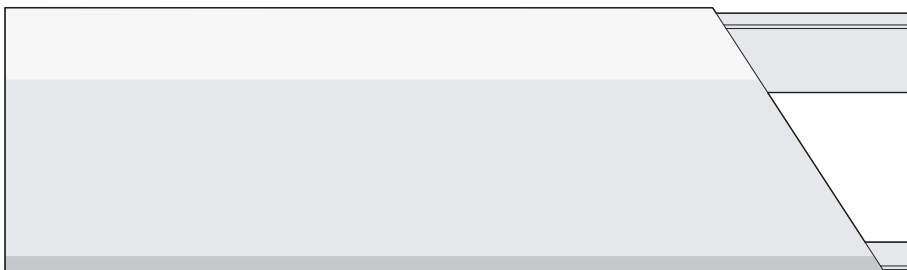
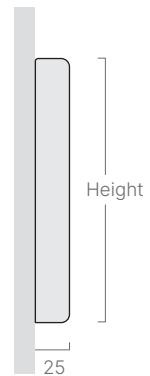

SSWGB1
25 (d) x 125 (h)

SSWGB2
25 (d) x 200 (h)

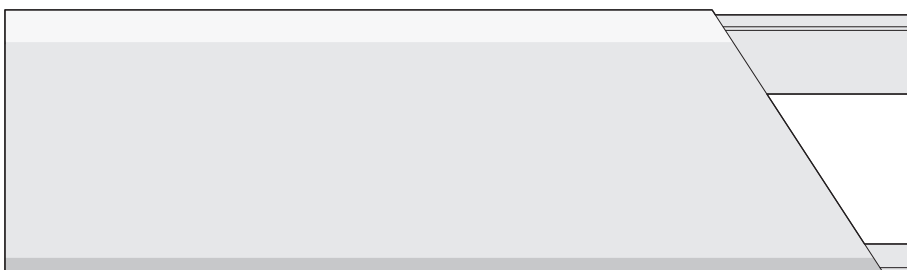
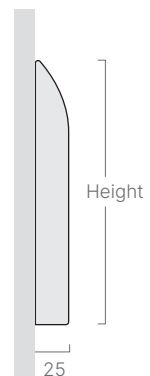

SSWGC1
25 (d) x 150 (h)

SSWGC2
25 (d) x 200 (h)

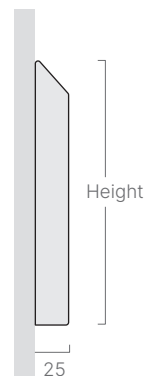

Visit: www.gradus.com
for full details



Dimensions shown are nominal
Illustrations are in mm



100%
Recyclable



NBS Source
PARTNER



WGR Rubber Wall Guards

Features

- > Black rubber minimises the appearance of scuffs and scrapes
- > Profiles absorb the effects of impact, minimising the extent of the damage
- > Suitable for both interior & exterior environments. Can be fixed to practically any substrate, including concrete, brickwork and blockwork
- > Internal and external corners are created through on-site mitring
- > Ideal for use in manufacturing, warehousing and loading bays, back of house retail, hospital service corridors and car parks

Information

- > Colour: Black only
- > Size: Supplied in 3.0m lengths
- > E-fender can be curved, contact Gradus for radii
- > Complementary corner guards available page 112

Components

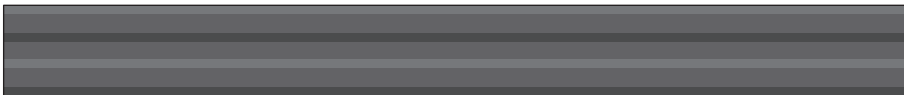

NEW

WGR60B
B-fender

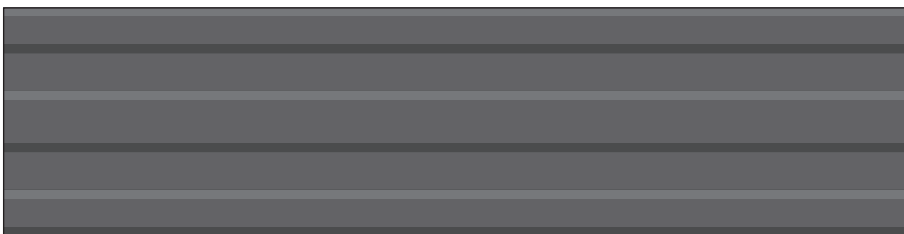

WGR150E
E-fender
30 (d) x 150 (h)

WGR200E
E-fender
30 (d) x 200 (h)

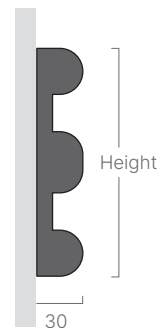

WGR107D
D-fender - includes galvanised steel fixing plate

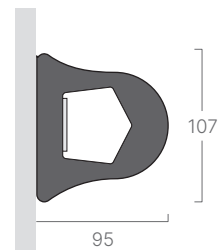



BHPA100 Bed Head Protector

Features

- > Fixed vertically on to walls in pairs as bed protectors or individually as chair protectors
- > Supplied as a pre-cut packaged system for ease of installation
- > Reveals provide neat joints and are made from a naturally bactericidal polymer that inhibits the growth of bacteria
- > 3 Extender options are available to provide increased projection allowing for protection of medical services and trunking
- > Designed to prevent damage to walls and wall mounted equipment from beds that are frequently moved around, elevated or inclined

Information

- > Comprising PVC-u covers, aluminium retainers PVC-u end caps and rubber spacers
- > Supplied as part of a kit 750mm long
2 units (including end caps)
- > Replacement components available to purchase
- > Utilises the WGA100 wall guard - see page 68
- > 33 colour options see page 42

Components

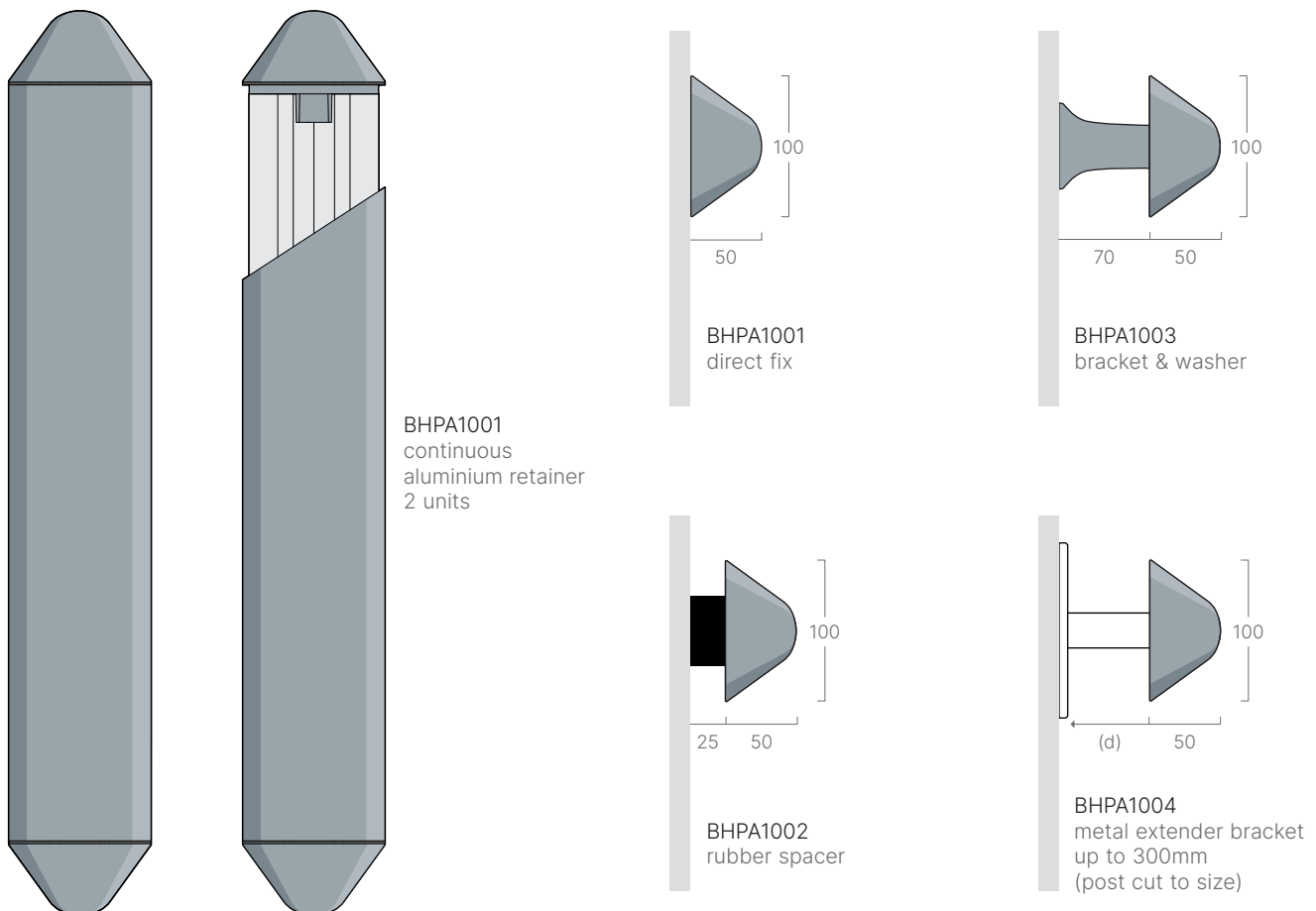



Furness General Hospital, South Lakes Birth Centre

BHPA125 Bed Head Protector

Features

- > Fixed vertically on to walls in pairs as bed protectors or individually as chair protectors
- > Supplied as a pre-cut packaged system for ease of installation
- > Comprising PVC-u covers, aluminium retainers, PVC-u end caps and brackets
- > Reveals provide neat joints and are made from a naturally bactericidal polymer that inhibits the growth of bacteria
- > Designed to prevent damage to walls and wall mounted equipment from beds that are frequently moved around, elevated or inclined

Information

- > Supplied as part of a kit 750mm long
2 units (including end caps)
- > Replacement components available to purchase
- > 32 colour options see page 42

Components

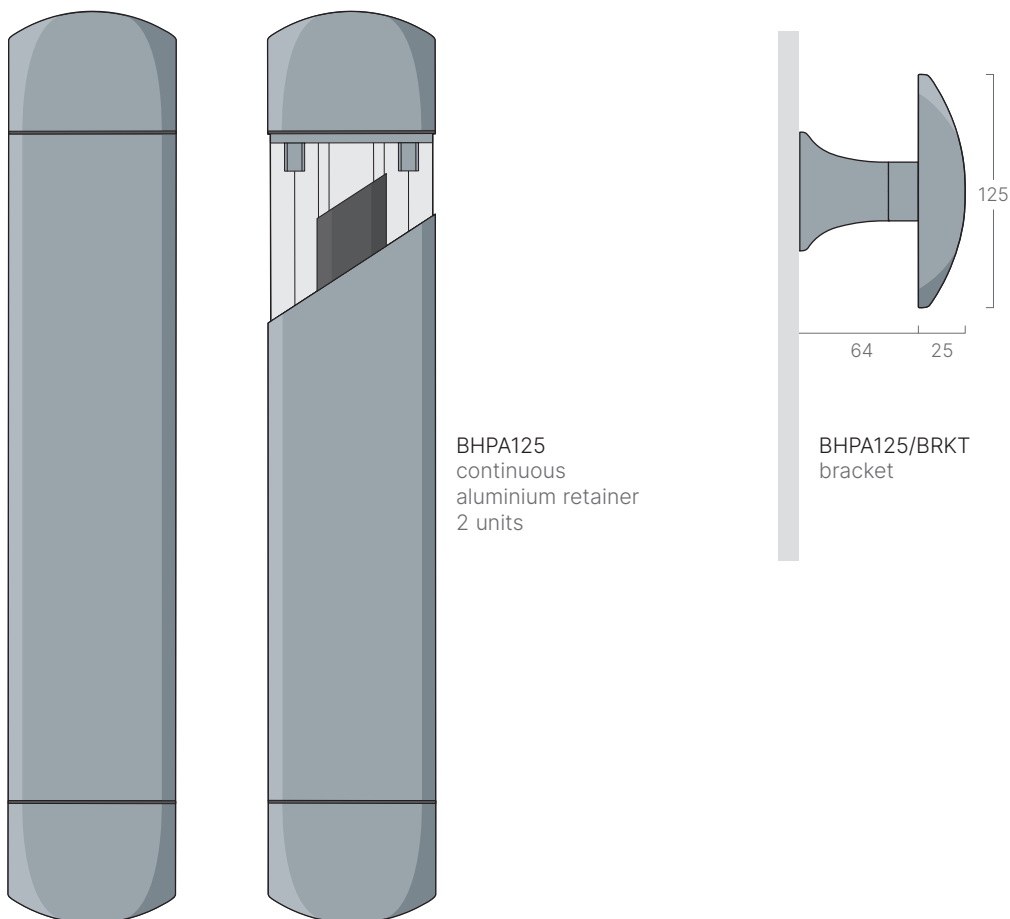



Handrails, Dual Rails & Combination Rail

Introduction

Gradus handrails, Dual Rails and combination rail are designed to offer pedestrian guidance and support in addition to a level of surface protection.

Designed for use in interior, horizontal circulation areas, they are suitable for use in a wide range of environments including healthcare, education, commercial office and transport.

The style of profile selected will depend on the types and levels of both pedestrian and wheeled traffic.

Handrails can also be combined with other profiles from the range to provide a complete protection solution.



Countess of Chester Hospital



Handrails



Dual Rails



Combination Rail

SHR40P Handrail

Features

- > Handrails are designed to offer pedestrian guidance and support in addition to a level of surface protection
- > Aluminium retainer with PVC-u covers and matching PVC-u accessories
- > Suitable for use in a wide range of environments including healthcare, education and transport
- > Reveals provide tight, neat joints and are made from a naturally bactericidal polymer that inhibits the growth of bacteria

Information

- > Supplied in 4.0m lengths
- > Accessories include reveal(s)
- > Replacement components available to purchase
- > Handrails feature a smooth finish in line with HBN 00-04
- > All options are designed to meet guidelines in HBN 00-10, HBN 00-04, BS 8300-2:2018 and Approved Documents K and M of The Building Regulations 2010
- > 32 colour options see page 42

Components



SHR40P
aluminium retainer with PVC-u cover

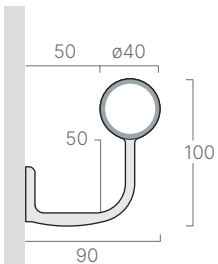

SHR403
anodised aluminium
standard bracket

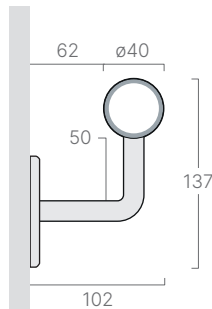

SHR40959
stainless steel
bracket

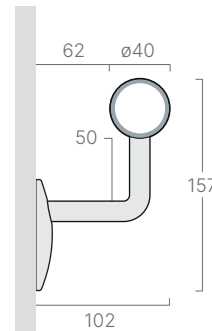

SHR40951
stainless steel
bracket with cover

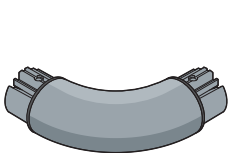

SHR402P
universal corner

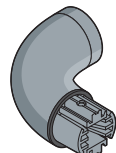

SHR404P
universal return

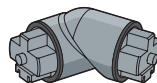

SHR408P
variable angle



SHR407
jointing splice



SHR406P
end stop

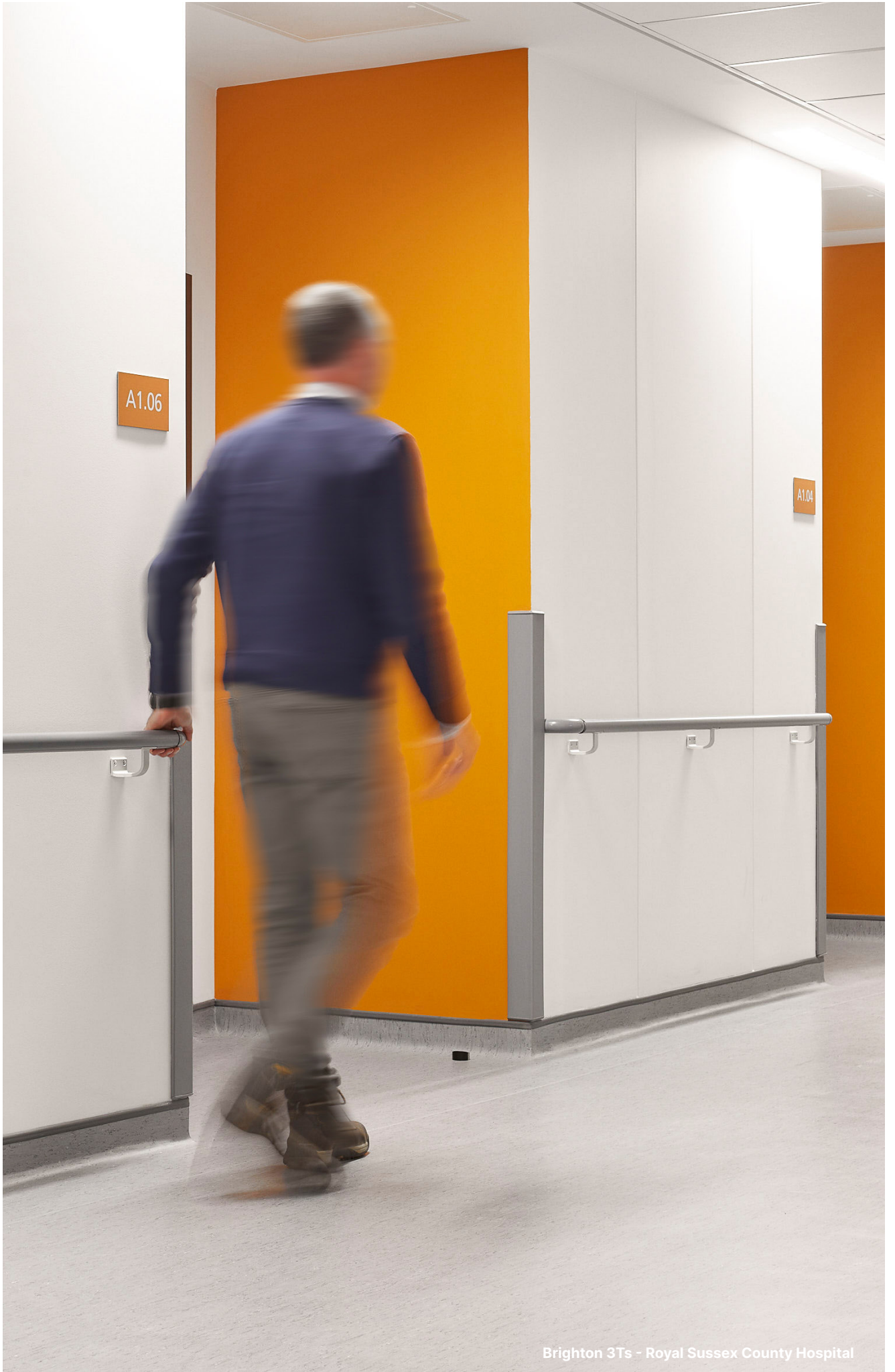

Brighton 3Ts - Royal Sussex County Hospital

SHR40W Handrail

Features

- > Aluminium handrail with wood effect finish with PVC-u accessories
- > 5 wood effects see page 41 for availability and page 55 for larger colour swatches
- > Accessories are available in 32 colours, recommended colours are Flint 032, Pebble 011 or Granite 004
- > Reveals provide tight, neat joints and are made from a naturally bactericidal polymer that inhibits the growth of bacteria

Information

- > Supplied in 4.0m lengths
- > Accessories include reveal(s)
- > Replacement components available to purchase
- > Handrails feature a smooth finish in line with HBN 00-04
- > All options are designed to meet guidelines in HBN 00-10, HBN 00-04, BS 8300-2:2018 and Approved Documents K and M of The Building Regulations 2010

Components

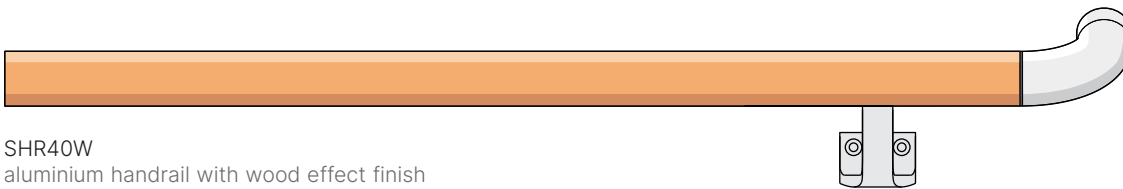

SHR40W
aluminium handrail with wood effect finish

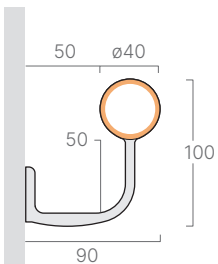

SHR403
anodised aluminium
standard bracket

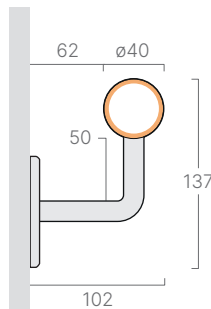

SHR40959
stainless steel
bracket

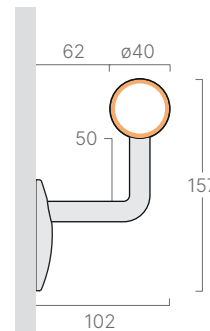

SHR40951
stainless steel
bracket with cover

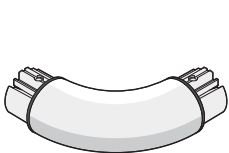

SHR402P
universal corner

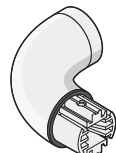

SHR404P
universal return

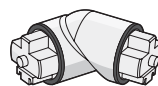

SHR408P
variable angle



SHR407
jointing splice



SHR406P
end stop



Brighton 3Ts - Royal Sussex County Hospital

SHR40S Handrail

Features

- > Handrails are designed to offer pedestrian guidance and support in addition to a level of surface protection
- > Silver anodised aluminium handrail with PVC-u accessories
- > Accessories are available in 32 colours, recommended colour is Flint 032
- > Reveals provide tight, neat joints and are made from a naturally bactericidal polymer that inhibits the growth of bacteria

Information

- > Supplied in 4.0m lengths
- > Accessories include reveal(s)
- > Replacement components available to purchase
- > Handrails feature a smooth finish in line with HBN 00-04
- > All options are designed to meet guidelines in HBN 00-10, HBN 00-04, BS 8300-2:2018 and Approved Documents K and M of The Building Regulations 2010

Components

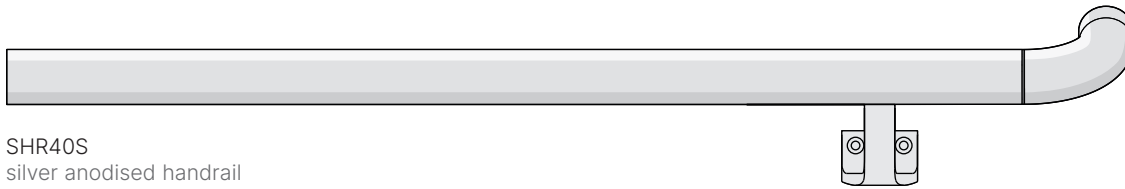

SHR40S
silver anodised handrail

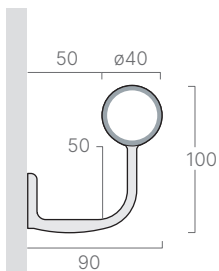

SHR403
anodised aluminium
standard bracket

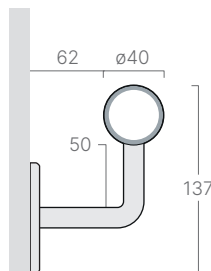

SHR40959
stainless steel
bracket

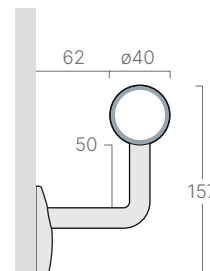

SHR40951
stainless steel
bracket with cover



SHR402P
universal corner

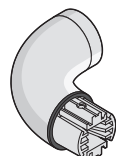

SHR404P
universal return

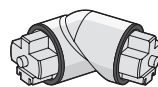

SHR408P
variable angle



SHR407
jointing splice



SHR406P
end stop



Brighton 3Ts - Royal Sussex County Hospital

THR450 Timber Handrail

Features

- > Solid timber handrail with stainless steel or solid timber finishing accessories
- > Supplied pre-lacquered – no on-site finishing required
- > Timber handrail also forms part of D200T Dual Rail (see page 94)
- > 4 timber species available

Information

- > Ash & Oak supplied in 3.2m lengths
- > Maple & Sapele supplied in 3.0m lengths
- > Replacement components available to purchase

Components

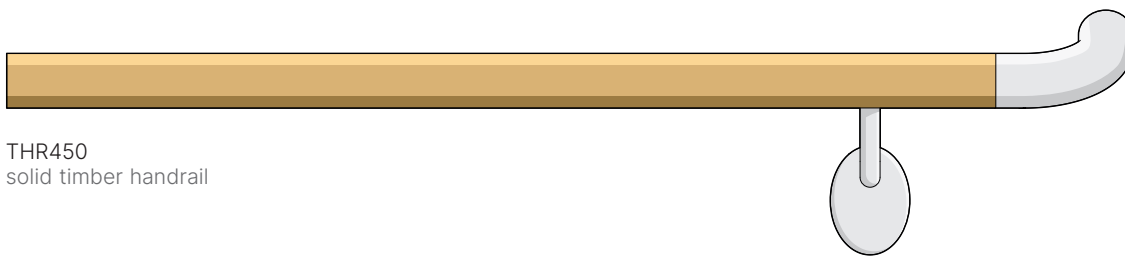

THR450
solid timber handrail

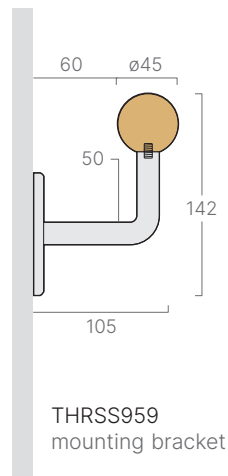
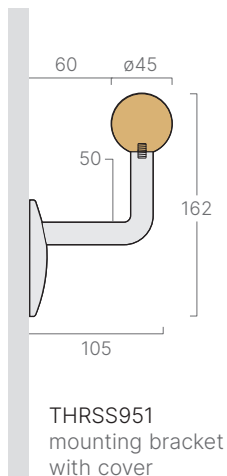

THRSS454
stainless steel option



THRSSFBC450
collar includes two
THR456 splices



THR454
timber option
THRSSFBC450 collar
required to connect
to handrail



THR456
splice

Colour Availability



401 Ash
LRV 42.92



402 Oak
LRV 28.06

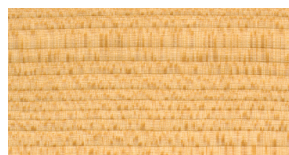

403 Maple
LRV 36.84

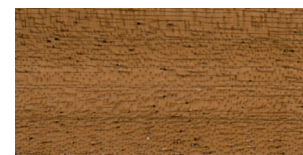

406 Sapele
LRV 15.11



Visit: www.gradus.com
for full details



Dimensions shown are nominal
Illustrations are in mm



100%
Recyclable



NBS Source
PARTNER



Brighton 3Ts - Royal Sussex County Hospital

SSHR42 Stainless Steel Handrail

Features

- > Comprise stainless steel handrail, brackets and matching accessories
- > Can be curved for bespoke applications (contact Gradus for radii information)
- > Suitable for interior environments

Information

- > Satin or Polished finish
- > Supplied in 3.0m lengths
- > Replacement components available to purchase
- > Complementary corner guards see 110

Components

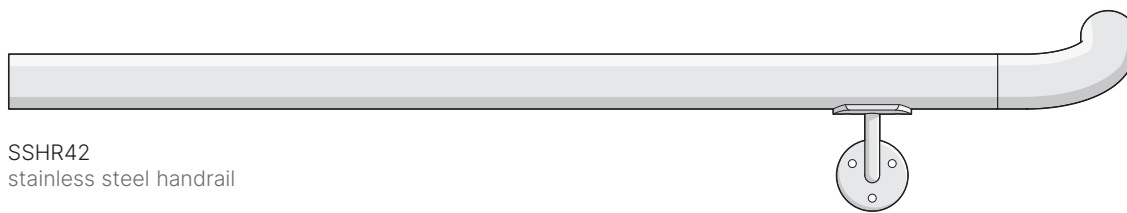

SSHR42
stainless steel handrail

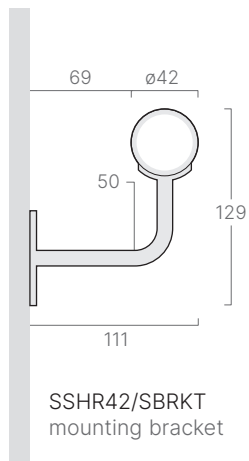

SSHR42/SBRKT
mounting bracket

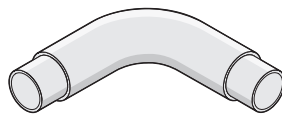

SSHR42/A90
inside/outside corner 90°

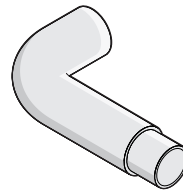

SSHR42/RET
wall return

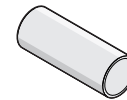

SSHR42/SPLICE
liner joint



SSHR42/EC
flat end cap

Colour Availability



Stainless Steel
LRV 59.95



D200P Dual Rail

Features

- > PVC-u wall guard with PVC-u handrail and PVC-u accessories
- > Dual Rail provides the ideal solution where both a handrail and wall guard are required as a combined system
- > Ideal for healthcare environments where pedestrian support is required in addition to protection against severe impact
- > Reveals provide tight, neat joints and are made from a naturally bactericidal polymer that inhibits the growth of bacteria

Information

- > Supplied in 4.0m lengths
- > Accessories include reveal(s)
- > For multiple length installations use handrail splice SHR407 with wall guard splice D200JS
- > Replacement components available to purchase
- > All options are designed to meet guidelines in HBN 00-10, HBN 00-04, BS 8300-2:2018 and Approved Documents K and M
- > Wall guard and handrail available in 32 colour options see page 42

Components



D200P
PVC-u wall guard with PVC-u handrail
and PVC-u accessories

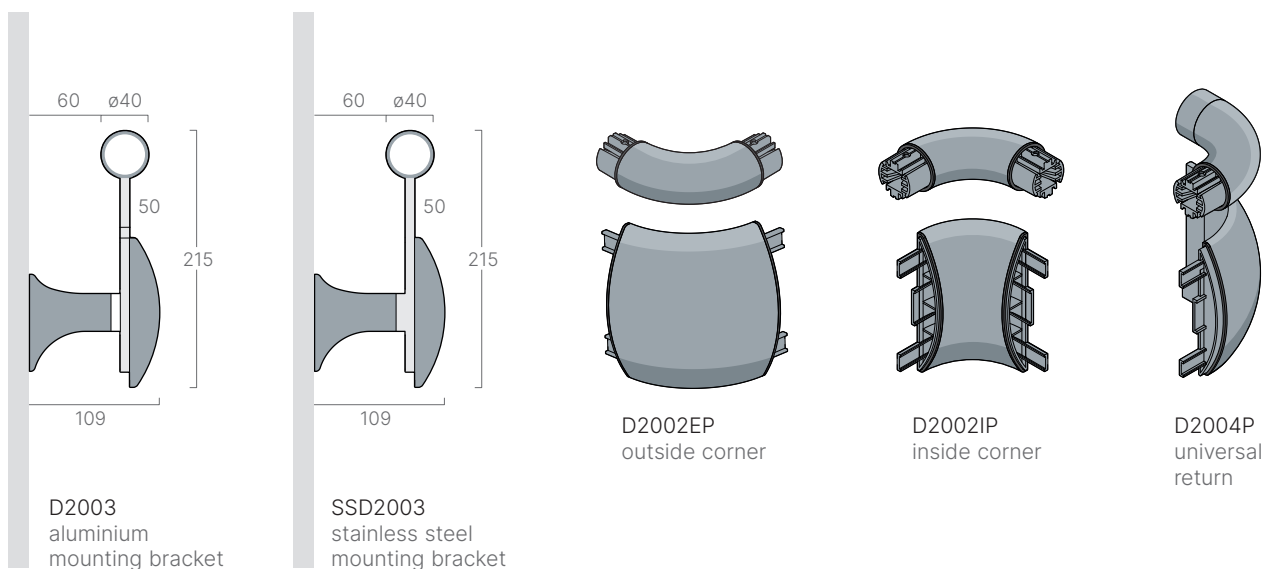



D200T Dual Rail

Features

- > PVC-u wall guard with timber handrail and stainless steel accessories
- > Dual Rail provides the ideal solution where both a handrail and wall guard are required as a combined system
- > Ideal for healthcare environments where pedestrian support is required in addition to protection against severe impact
- > Reveals provide tight, neat joints and are made from a naturally bactericidal polymer that inhibits the growth of bacteria

Information

- > Supplied in 4.0m lengths
- > Accessories include reveal(s)
- > For multiple length installations use THRSSFBC450 with wall guard splice D200JS
- > Replacement components available to purchase
- > All options are designed to meet guidelines in HBN 00-10, HBN 00-04, BS 8300-2:2018 and Approved Documents K and M
- > Wall Guard available in 32 colour options see page 42
Handrail available in 4 timber species see page 88

Components

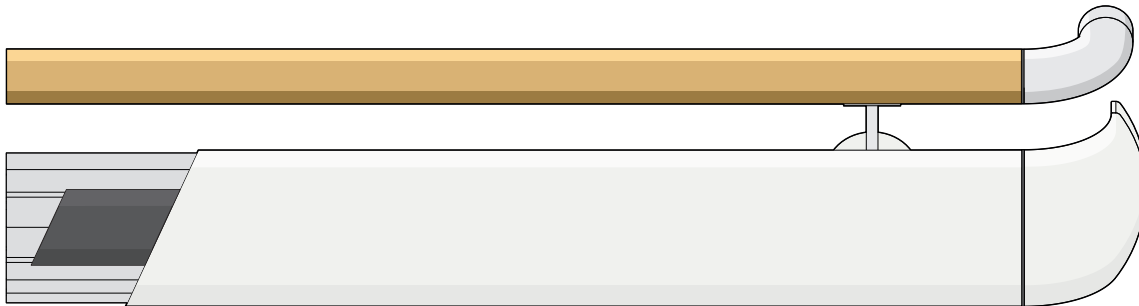

D200T

PVC-u wall guard with timber handrail and stainless steel accessories

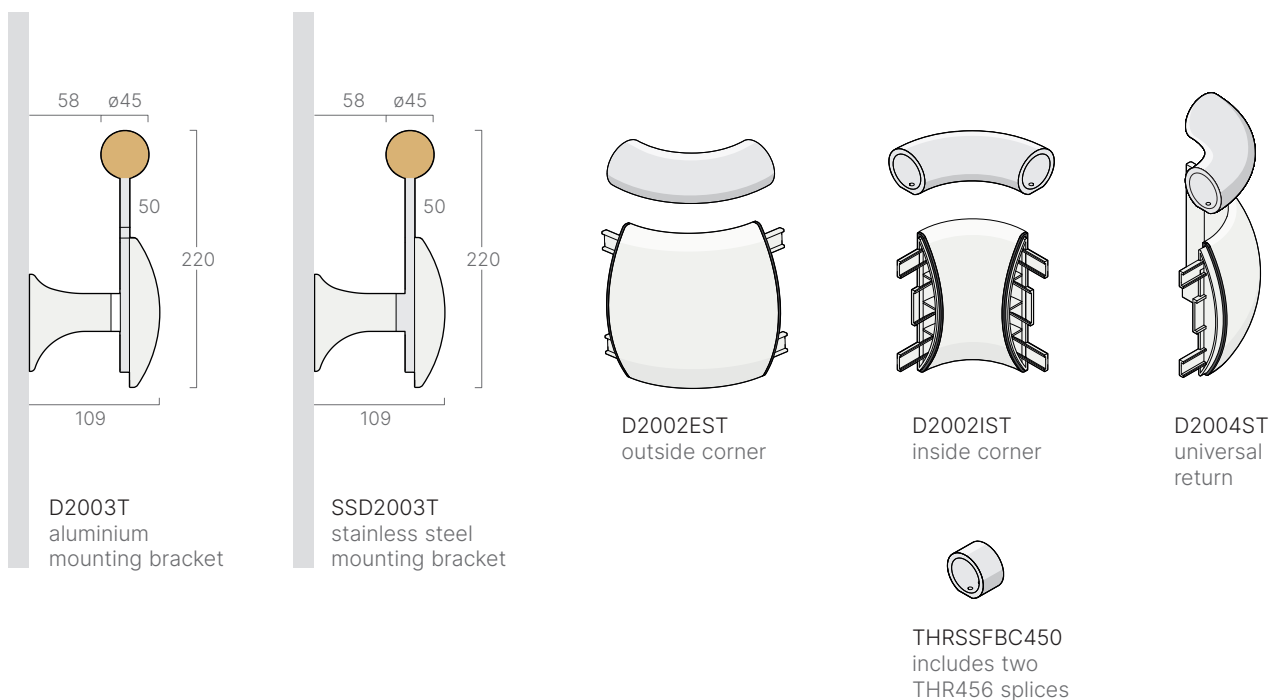

D200W Dual Rail

Features

- > PVC-u wall guard with wood effect aluminium handrail and PVC-u accessories
- > Dual Rail provides the ideal solution where both a handrail and wall guard are required as a combined system
- > Ideal for healthcare environments where pedestrian support is required in addition to protection against severe impact
- > Reveals provide tight, neat joints and are made from a naturally bactericidal polymer that inhibits the growth of bacteria

Information

- > Supplied in 4.0m lengths
- > Accessories include reveal(s)
- > For multiple length installations use handrail splice SHR407 with wall guard splice D200JS
- > Replacement components available to purchase
- > All options are designed to meet guidelines in HBN 00-10, HBN 00-04, BS 8300-2:2018 and Approved Documents K and M
- > Wall Guard available in 32 colour options see page 42
Handrail available in 5 wood effects see page 55

Components

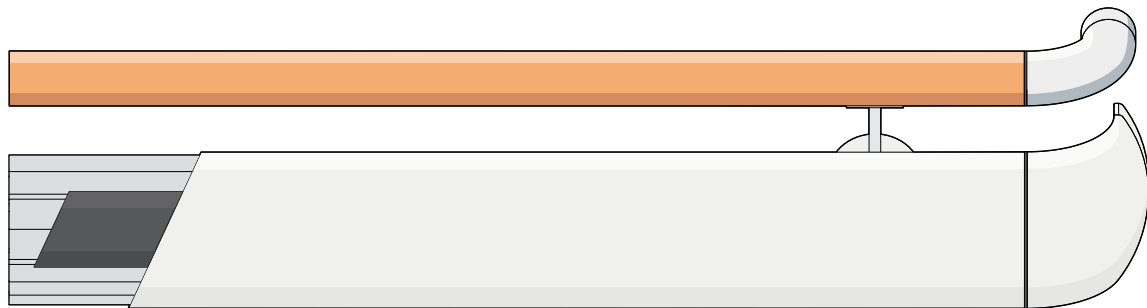

D200W

PVC-u wall guard with wood effect aluminium handrail and PVC-u accessories

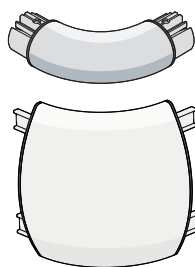
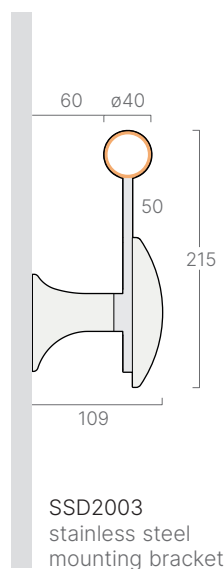
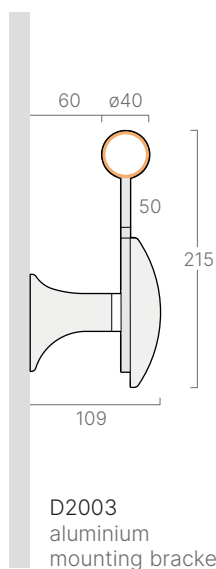

D2002ECP
outside corner

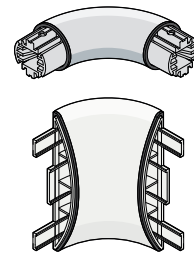

D2002ICP
inside corner

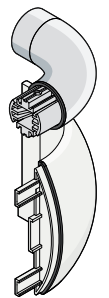

D2004CP
universal
return



Visit: www.gradus.com
for full details



Dimensions shown are nominal
Illustrations are in mm



100%
Recyclable



NBS Source
PARTNER

D200S Dual Rail

Features

- > PVC-u wall guard with silver anodised aluminium handrail and PVC-u accessories
- > Dual Rail provides the ideal solution where both a handrail and wall guard are required as a combined system
- > Ideal for healthcare environments where pedestrian support is required in addition to protection against severe impact
- > Reveals provide tight, neat joints and are made from a naturally bactericidal polymer that inhibits the growth of bacteria

Information

- > Supplied in 4.0m lengths
- > Accessories include reveal(s)
- > For multiple length installations use handrail splice SHR407 with wall guard splice D200JS
- > Replacement components available to purchase
- > All options are designed to meet guidelines in HBN 00-10, HBN 00-04, BS 8300-2:2018 and Approved Documents K and M
- > Wall Guard available in 32 colour options see page 42
Handrail available in Silver Anodised finish

Components

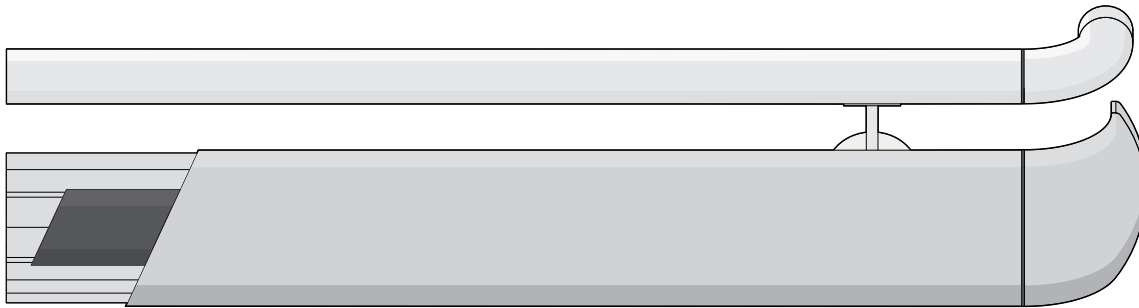

D200S

PVC-u wall guard with silver anodised aluminium handrail and PVC-u accessories

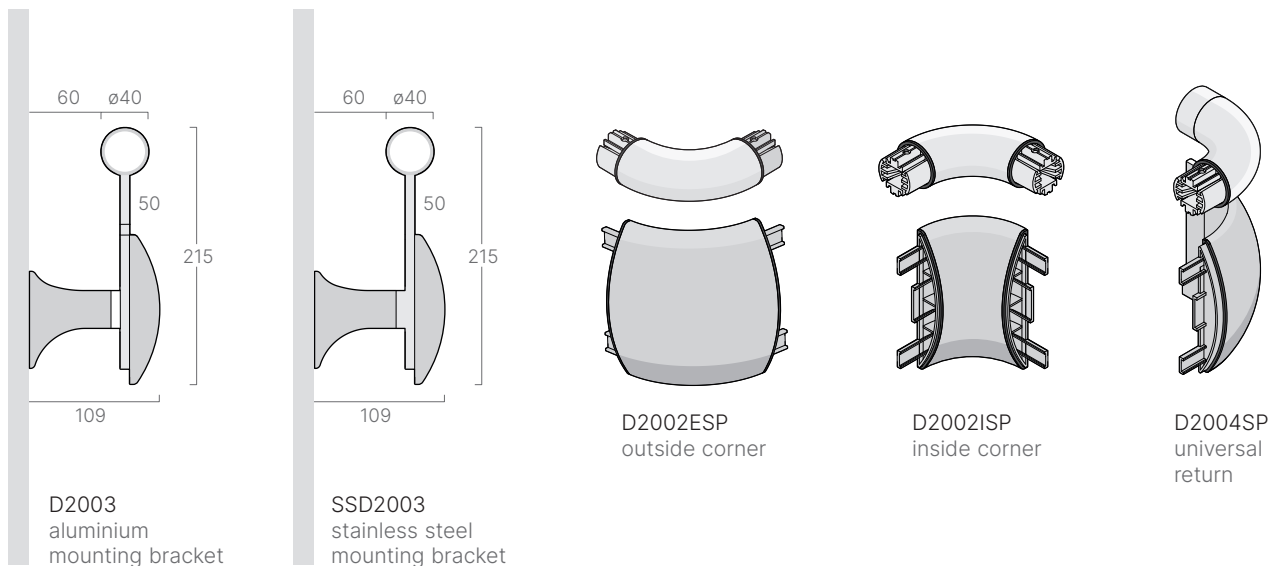

Visit: www.gradus.com
for full details



Dimensions shown are nominal
Illustrations are in mm



100%
Recyclable



NBS Source
PARTNER

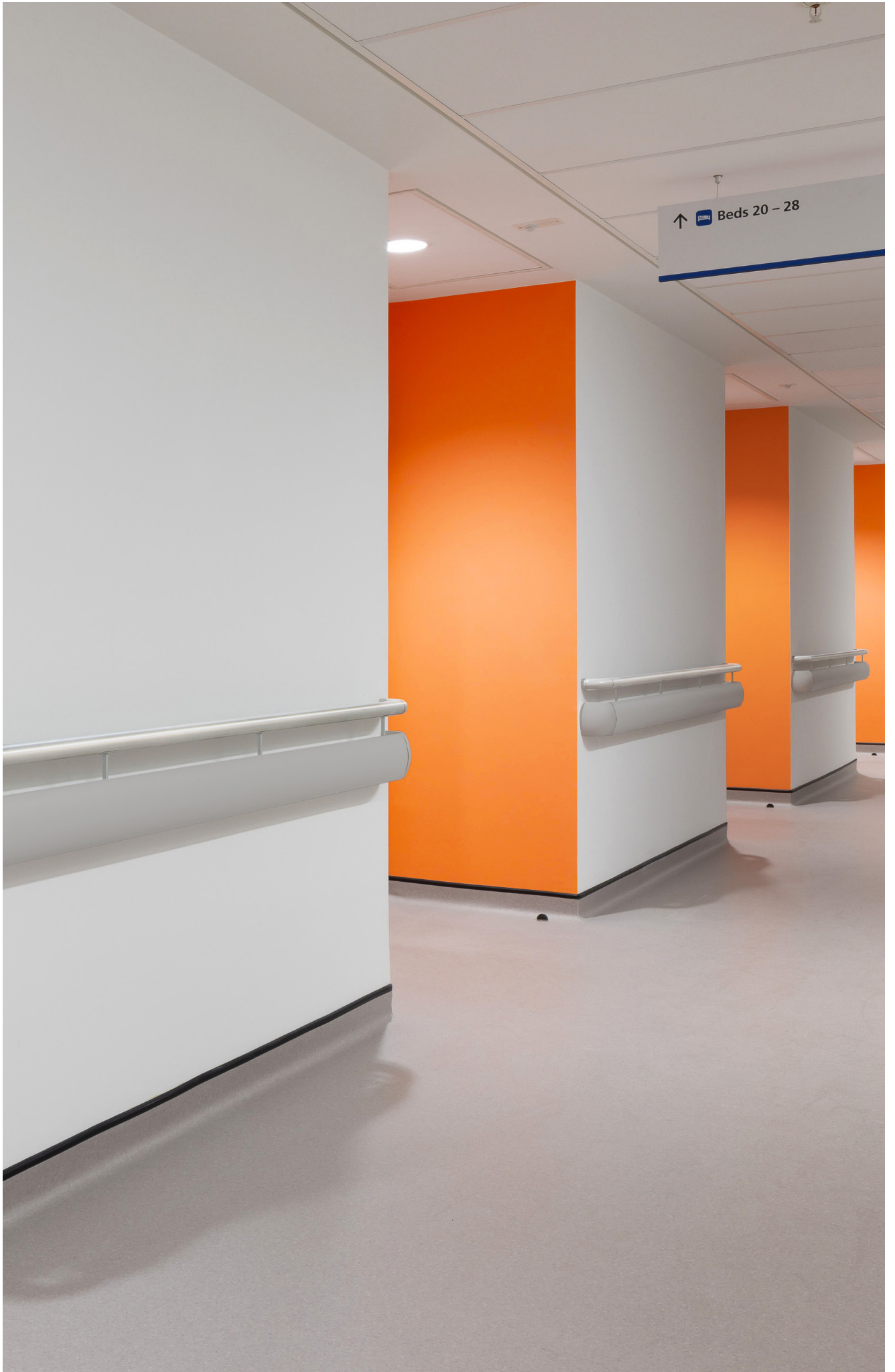

CHR110 Combination Rail

Features

- > Modular system comprising PVC-u covers, aluminium retainers and a full range of finishing accessories
- > Replaceable, through coloured, easy-to-clean covers - textured to conceal the effects of impact and abrasion
- > Closed slots to ensure ends remain in place in event of severe high impact
- > Reveals provide tight, neat joints and are made from a naturally bactericidal polymer that inhibits the growth of bacteria

Information

- > Supplied in 4.0m lengths
- > Accessories include reveal(s)
- > For multiple length installations use splice D200JS
- > Replacement components available to purchase
- > 32 colour options see page 42

Components



CHR110
continuous aluminium retainer with PVC-u cover

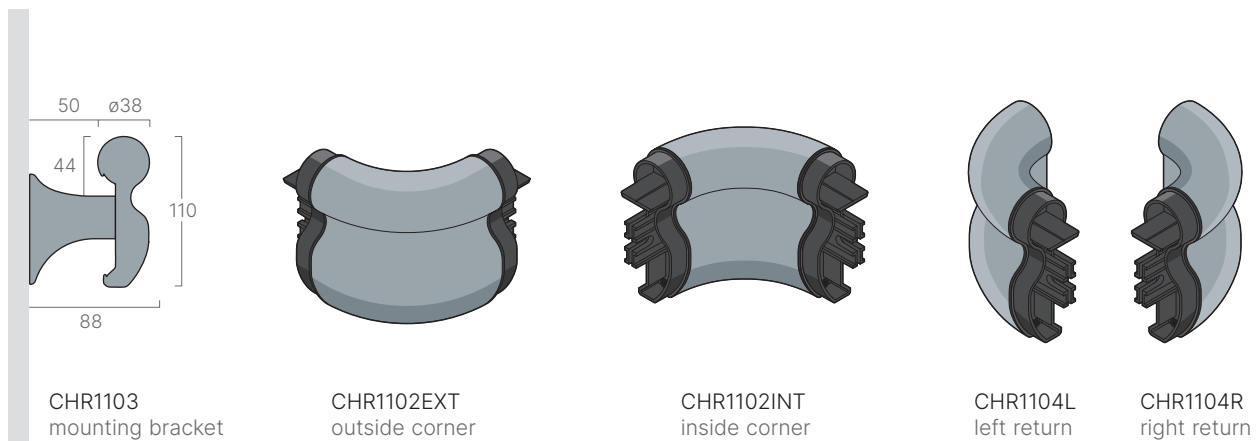



CHR160 Combination Rail

Features

- > Modular system comprising PVC-u covers, aluminium retainers and a full range of finishing accessories
- > Replaceable, through coloured, easy-to-clean covers - textured to conceal the effects of impact and abrasion
- > Closed slots to ensure ends remain in place in event of severe high impact
- > Reveals provide tight, neat joints and are made from a naturally bactericidal polymer that inhibits the growth of bacteria

Information

- > Supplied in 4.0m lengths
- > Accessories include reveal(s)
- > For multiple length installations use splice D200JS
- > Replacement components available to purchase
- > 32 colour options see page 42

Components

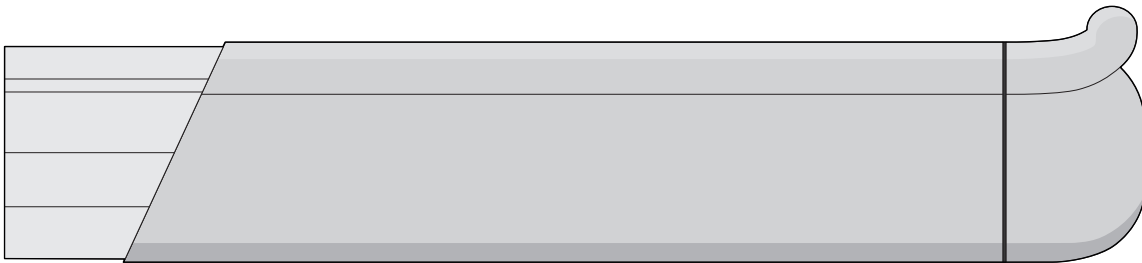

CHR160
continuous aluminium retainer with PVC-u cover

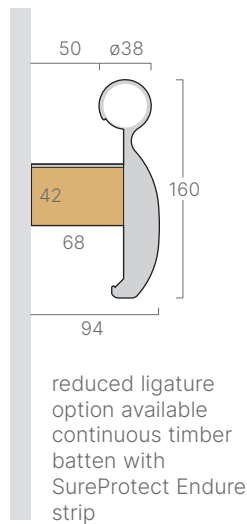
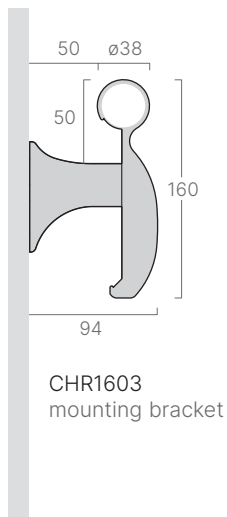

CHR1602
universal corner
inside / outside

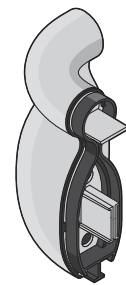

CHR1604L
left return

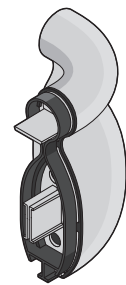

CHR1604R
right return



Visit: www.gradus.com
for full details



Dimensions shown are nominal
Illustrations are in mm



100%
Recyclable



NBS Source
PARTNER



Countess of Chester Hospital

Corner Guards

Introduction

Corners are one of the most vulnerable parts of a building and when left exposed are often damaged from everyday wheeled and pedestrian traffic. Corner guards are ideal for reducing maintenance costs and maintaining interior appearances and can be combined with other Gradus protection products to provide a complete solution. Gradus corner guards are available in a variety of material types, styles and heights to suit all building requirements.





High Impact Corner Guards



Standard Corner Guards



Adjustable Angle Corner Guards



Clear Corner Guards



Aluminium and Stainless Steel Corner Guards



Rubber Corner Guards

High Impact

PVC-u Corner Guards

Features

- > Surface mount corner guards comprising aluminium or PVC-u retainer, PVC-u cover and top/bottom caps
- > Replaceable, through coloured, easy-to-clean covers - textured to conceal the effects of impact and abrasion
- > Aluminium retainer provides additional support for weaker substrates. PVC-u retainer is suitable for gently undulating substrates, made with up to 100% recycled material
- > Supplied in package format with a pre-cut retainer, cover and 2 caps

Information

- > Height: 7 options: 0.8m, 1.0m, 1.22m, 2.0m, 2.44m, 2.7m and 4.0m
- > Can also be cut down to suit specific requirements with additional top/bottom caps available to order
- > Replacement components available to purchase
- > 34 colour options see page 42
- > Environment: Interior

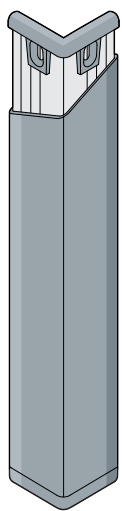

CGH5090
aluminium
retainer with
PVC-u cover

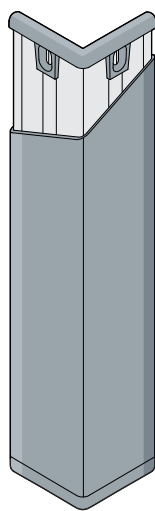

CGH7590
aluminium
retainer with
PVC-u cover

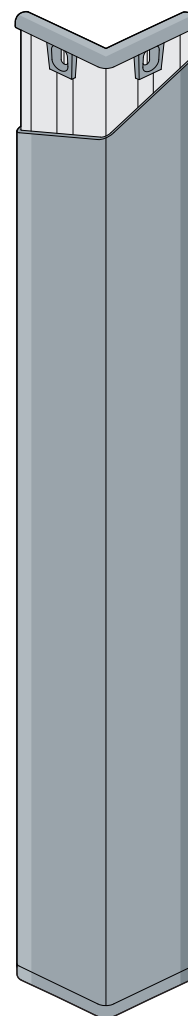

CGH75135
aluminium
retainer with
PVC-u cover

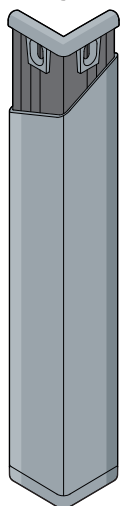

NEW
CGH5090P
PVC-u
retainer and
cover

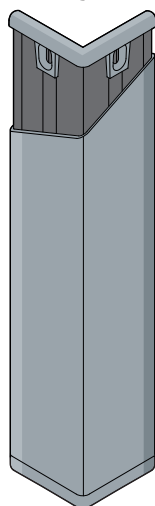

NEW
CGH7590P
PVC-u
retainer and
cover

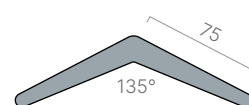
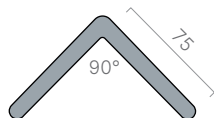
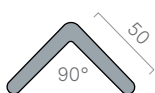

Visit: www.gradus.com
for full details



Dimensions shown are nominal
Illustrations are in mm



100%
Recyclable



NBS Source
PARTNER



Standard

PVC-u Corner Guards

Features

- > One-piece, surface mount corner guards
- > Cost effective solution ideal for use in environments such as hotels, leisure clubs, schools, offices and nursing homes
- > Through coloured, easy-to-clean PVC-u – textured to conceal the effects of impact and abrasion
- > Supplied with tape for ease of installation or without, for installation with a suitable adhesive

Information

- > Height: 7 options: 0.8m, 1.0m, 1.22m, 2.0m, 2.44m, 2.7m and 4.0m
- > Can also be cut down to suit specific requirements
- > 35 colour options see page 42
- > Environment: Interior

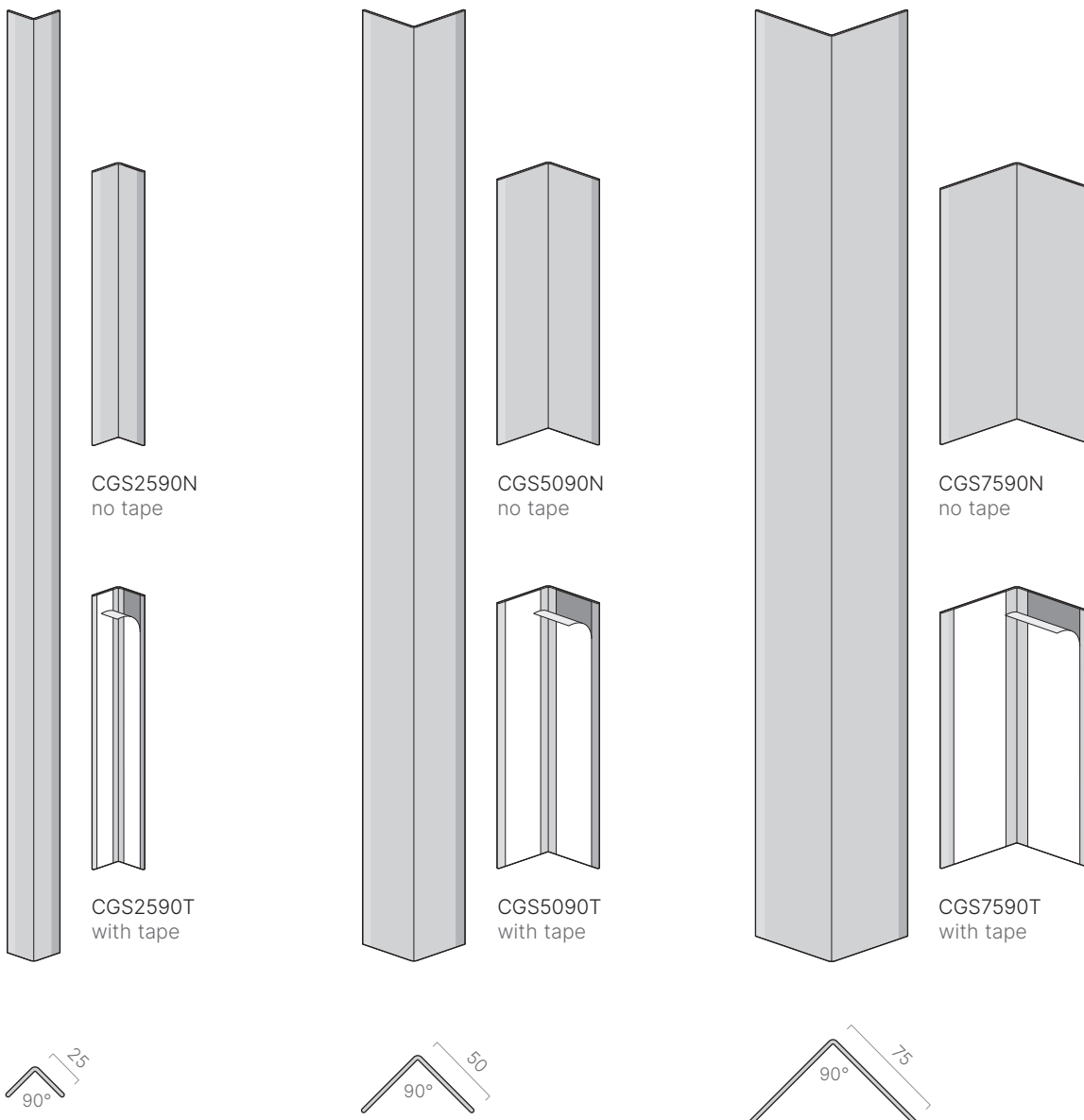

Visit: www.gradus.com
for full details



Dimensions shown are nominal
Illustrations are in mm



100%
Recyclable



NBS Source
PARTNER



Leicester Royal Infirmary

Adjustable Angle

PVC-u Corner Guards

Features

- > One-piece, surface mount corner guard – through coloured and textured to conceal the effects of impact
- > Cost effective solution for irregular angle corners
- > Height: 0.8m, 1.0m, 1.22m, 2.0m, 2.44m, 2.7m and 4.0m
- > Colour: 001 Chalk, 006 Ivory, 003 Clay, 005 Shale, see page 42
- > Can also be cut down to suit specific requirements
- > Environment: Interior

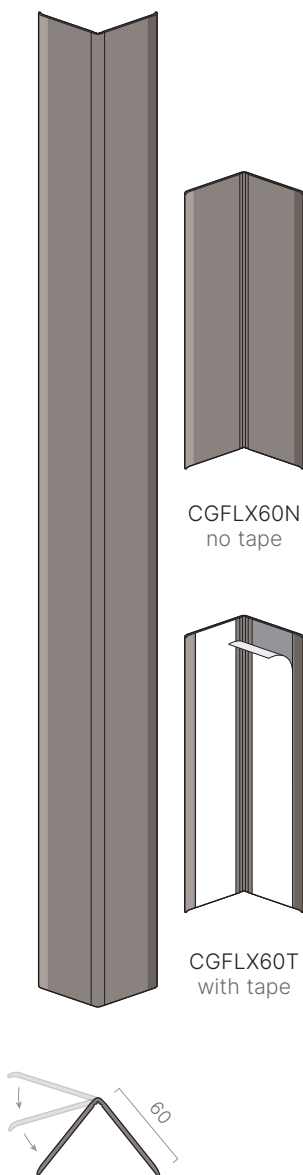

Clear

PVC-u Corner Guards

Features

- > One-piece, surface mount corner guards with a smooth clear finish
- > Allows wallcoverings and finishes to be protected whilst enabling pattern and colour to show through
- > Height: 0.8m, 1.0m, 1.22m, 2.0m, 2.44m, 2.7m and 4.0m
- > Can also be cut down to suit specific requirements
- > Environment: Interior

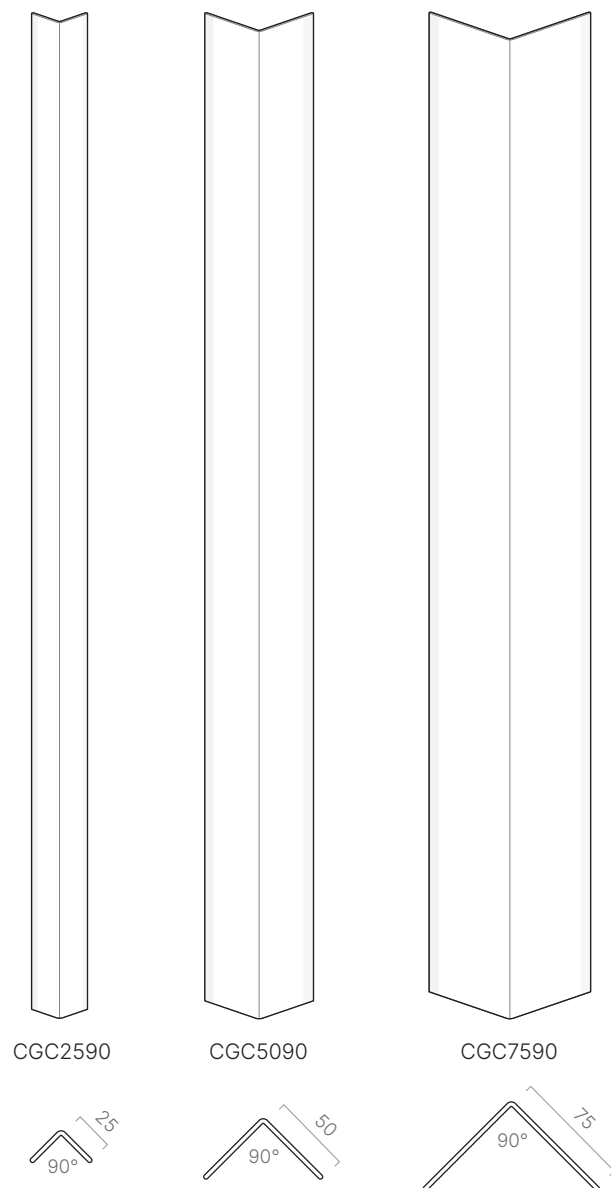

Visit: www.gradus.com
for full details



Dimensions shown are nominal
Illustrations are in mm



100%
Recyclable



NBS Source
PARTNER



Adjustable Angle PVC-u Corner Guards



Clear PVC-u Corner Guards

Stainless Steel

Corner Guards

Features

- > One-piece, surface mount corner guards
- > Hygienic, durable protection for applications such as kitchens, canteens and laboratories
- > Finish: Satin
- > Height: 1.25m, 2.5m
- > Material: 304 Grade Stainless Steel – 1.5mm
- > Environment: Interior

Chequer Plate

Aluminium Corner Guard

Features

- > One-piece, surface mount corner guards
- > Lightweight, easy-to-install
- > Embossed chequer pattern conceals the effects of impact and abrasions
- > Height: 1.25m
- > Material: aluminium
- > Environment: Interior & Exterior

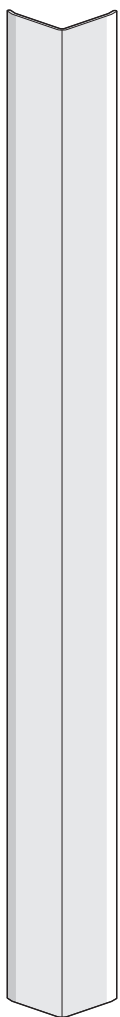

SSCG5090D
drilled

SSCG5090U
undrilled

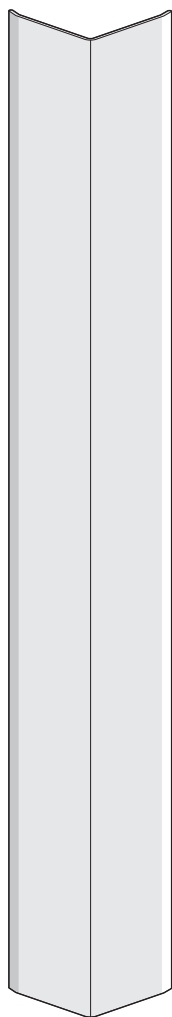

SSCG7590D
drilled

SSCG7590U
undrilled

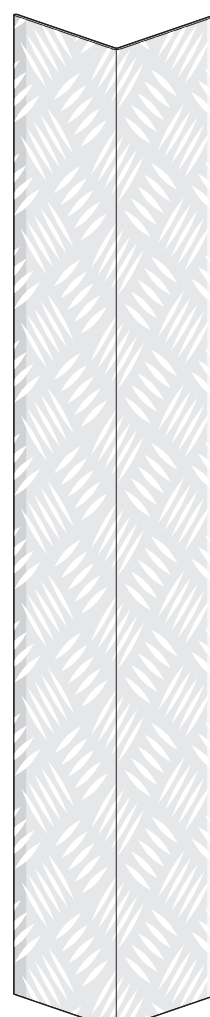

CPACG10090/1250
undrilled

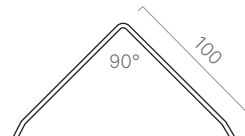
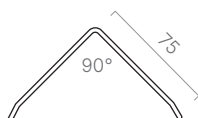
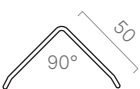

Visit: www.gradus.com
for full details



Dimensions shown are nominal
Illustrations are in mm



100%
Recyclable



NBS Source
PARTNER



Stainless Steel Corner Guards



Chequer Plate Aluminium Corner Guard

Rubber

Corner Guard

Features

- > One-piece, surface mount corner guard
- > Heavy duty protection against damage caused by wheeled traffic
- > Ideal for use in manufacturing, warehousing and loading bays, back of house retail, hospital service corridors and car parks
- > Colour: Black
- > Height: 3.0m
- > Environment: Interior & Exterior

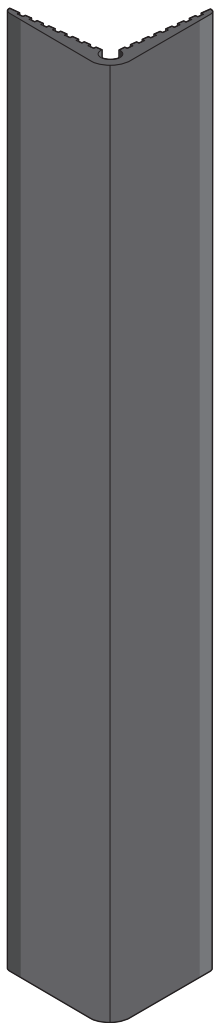

CGR119
supplied undrilled

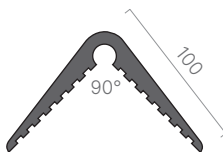

Reflective

Corner Guard

Features

- > One-piece, surface mount corner guards incorporating impact absorption pads and diamond grade reflectors
- > Highly visible to alert vehicle users to potential hazards
- > Ideal for loading bays and basement car parks where vehicles are manoeuvring in tight spaces
- > Colour: Black/Yellow/Reflectors
- > Height: 890mm
- > Environment: Interior & Exterior

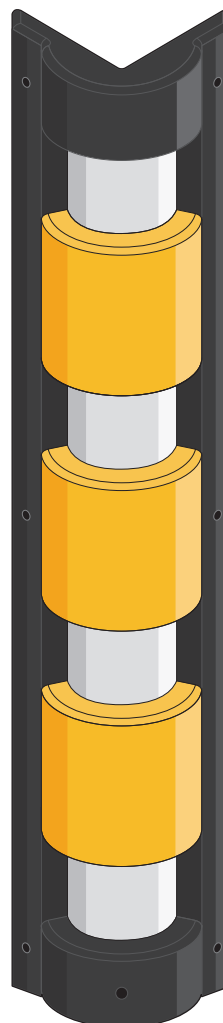

CGCW-890-BY
supplied undrilled

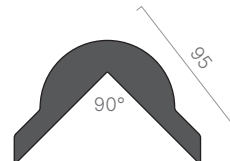

Visit: www.gradus.com
for full details



Dimensions shown are nominal
Illustrations are in mm



100%
Recyclable



NBS Source
PARTNER



Door Protection

Introduction

Door faces, edges and frames are vulnerable to damage due to the constant flow of pedestrian and wheeled traffic. A variety of door protection products are available to help prevent damage, conceal existing damage and highlight the door and door furniture, to assist the visually impaired and to meet guidelines in The Building Regulations 2010: Approved Document M and BS 8300-2:2018.



Countess of Chester Hospital



Stainless Steel - Kickplate and Pushplate



SureProtect Endure - Fully Clad



Stainless Steel - Kickplate



SureProtect Endure - Kickplate



SureProtect Endure - Kickplate

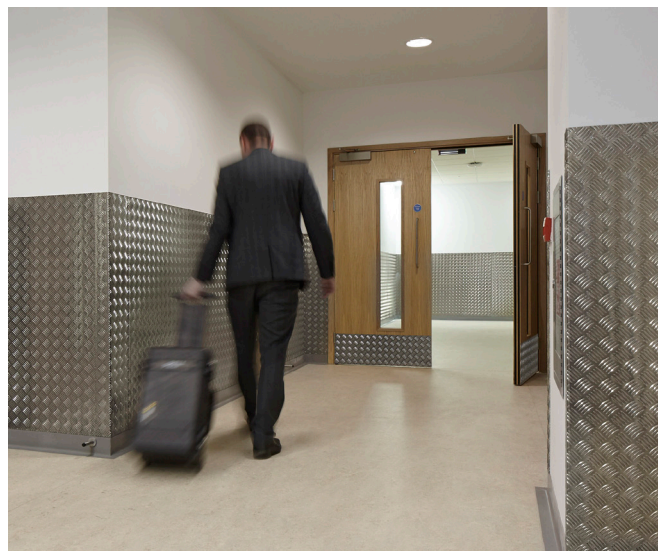

Aluminium Chequer - Kickplate

Door Face Protection

K15 – Kickplates and Pushplates

- > Cut from SureProtect Endure PVC-u sheets to size requirements
- > 35 colour options available
- > Maximum size: 2440mm x 1220mm
- > Thickness: 1.5mm
- > Tested as resistant to chemical, bacterial and fungal growth
- > Option to cut bespoke shapes
- > For interior environments
- > Available with double sided tape for easy installation (only for application on doors)



K130/SPEC – Kickplates and Pushplates

- > 304 grade Stainless Steel with Satin finish (other grades available)
- > Maximum size: 2500mm x 1250mm
- > Thickness: 1.5mm
- > Suitable for hygienic environments e.g. food preparation areas and laboratories
- > Cut to individual size requirements
- > Supplied drilled or undrilled
- > Suitable for both interior and exterior environments



CPA2 – Kickplates and Pushplates

- > Aluminium with embossed chequer pattern
- > Maximum size: 2500mm x 1250mm
- > Thickness: 2mm
- > Embossed texture conceals the effects of impact damage
- > Cut to individual size requirements
- > Supplied drilled or undrilled
- > Suitable for both interior and exterior environments

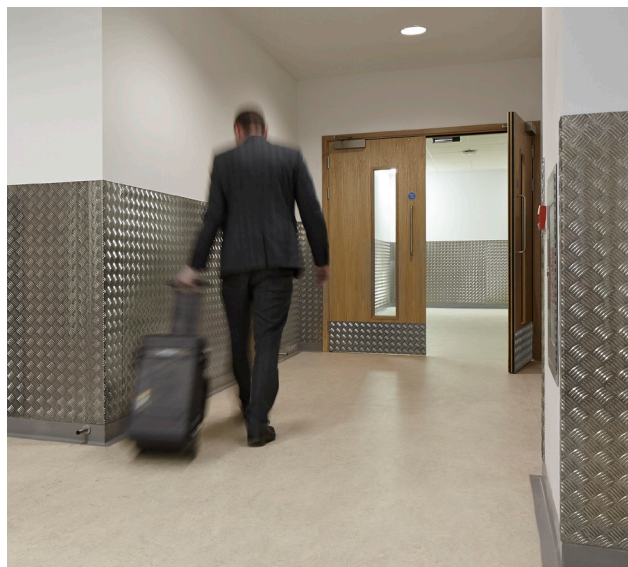

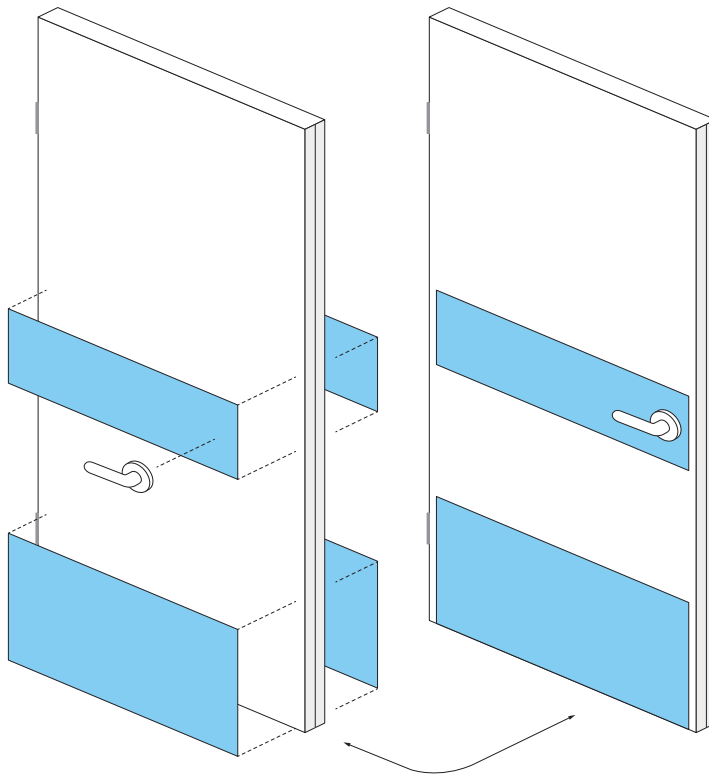

Kickplate and Pushplate example

Installation method for a surface mounted kickplate and pushplate. Protective sheet can be applied to new doors by the door manufacturer or surface mounted by a contractor as part of building/refurbishment works.

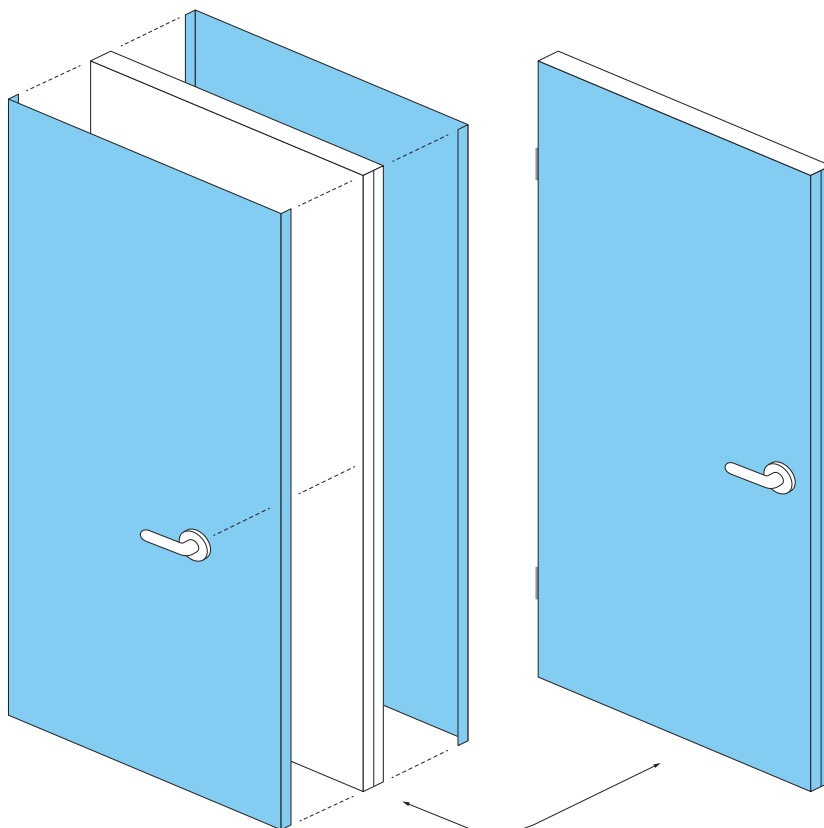

'Fully Clad' example

'Fully Clad' with SureProtect Endure thermoformed / post formed edges applied to new doors by the door manufacturer. The provision of intumescent fire and smoke seals provided by the door manufacturer.

(supply only, usually formed and bonded by a door specialist)

Door Face Protection

Typical examples (including water jet cutting)

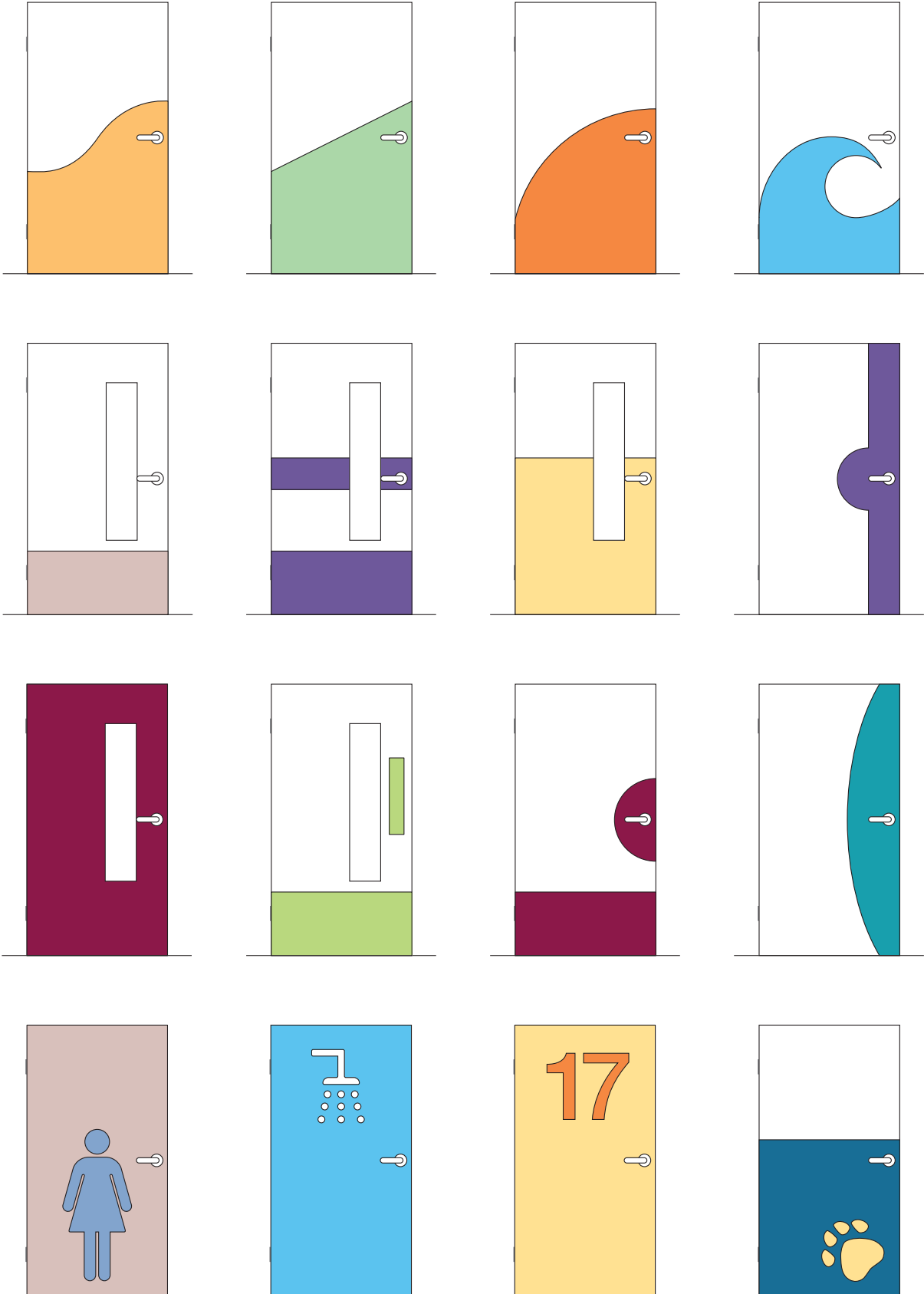

Fire Rated Door Edge Guards

Fire Rated Door Edge Guards are fitted with intumescent fire and smoke seals which are vandal-resistant yet easy to replace. These profiles are ideal for maintaining the integrity of the fire door and can be used on the front and back edges of fire resisting door sets.

Standard finishes are Satin Anodised Aluminium (SAA) or standard PVC-u colours available from the SureProtect Endure range. This helps to provide colour and tonal contrast to door edges to aid the visually impaired and to meet the guidelines in BS 8300-2:2018 and Approved Document M. Profiles are available with a choice of seals dependent on application (brush, neoprene blade or blank intumescent).

(Supply only, usually installed by a door specialist)

Information

- > Fire tested to BS 476: Part 20 & 22 for 30 and 60 minutes
- > Reduces maintenance costs and protects vulnerable entry areas



Aluminium

Aluminium: profile designed for doors (single or double doorsets) where there is the need to cut around the locks, latches and hinges.

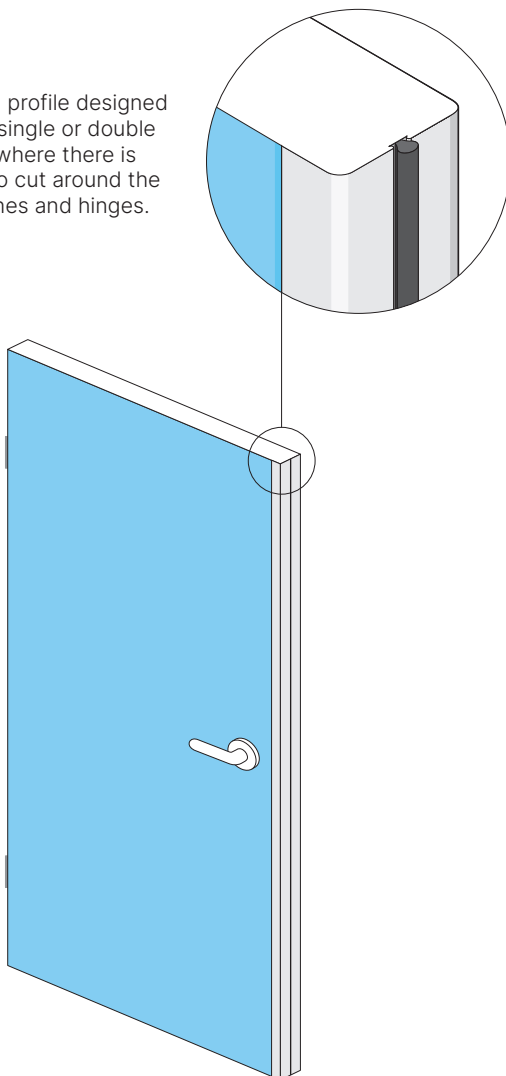

PVC-u

PVC: radius profile designed for doors (single or double doorsets) where there is the need to cut around the locks, latches and hinges.

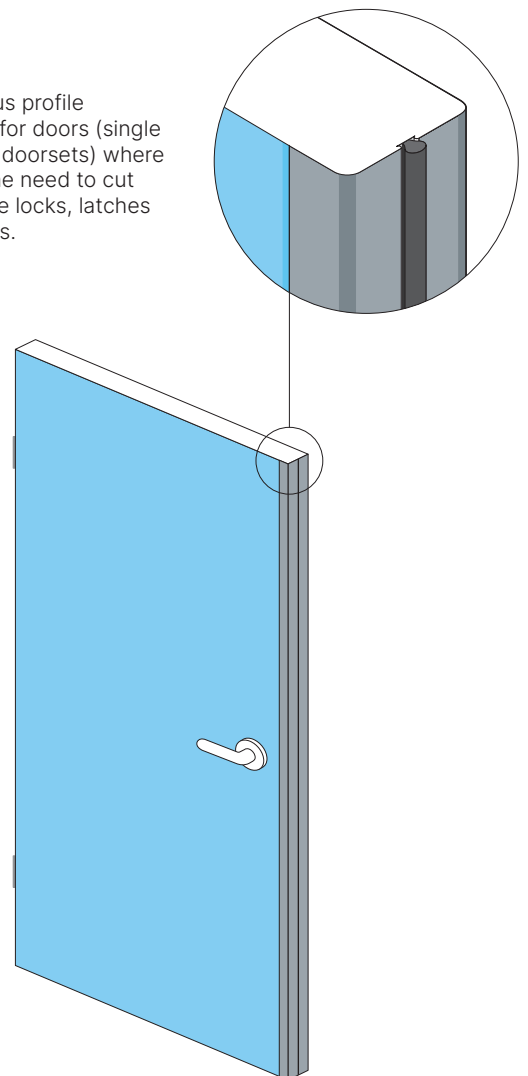

Door Frame Protection

Door Frame Protection

SureProtect Endure PVC-u sheet offers excellent flexibility through the versatility of forming into bespoke profiles, allowing functionality to be combined with aesthetics and offering an endless range of cladding possibilities, to protect as well as offering tonal contrast to aid the visually impaired.

SureProtect Endure and SureProtect Design sheet can be formed into a variety of profiles, with the most frequently used profiles being 'L' and 'U' shapes. These profiles can be used to clad a door frame by the door manufacturer, or on site with the use of thermoformed sections.

Fully cladding a door frame can be achieved by the door manufacturer in the factory or fabricated on-site by the use of thermoforming SureProtect Endure sheet material. 'Off-site' thermoforming can be produced from accurate site dimensions and/or oversized to be trimmed down on-site.

For lead times and quotations for bespoke forming, contact Gradus Technical Support on 01625 428922

(Supply only, usually installed by a door specialist)

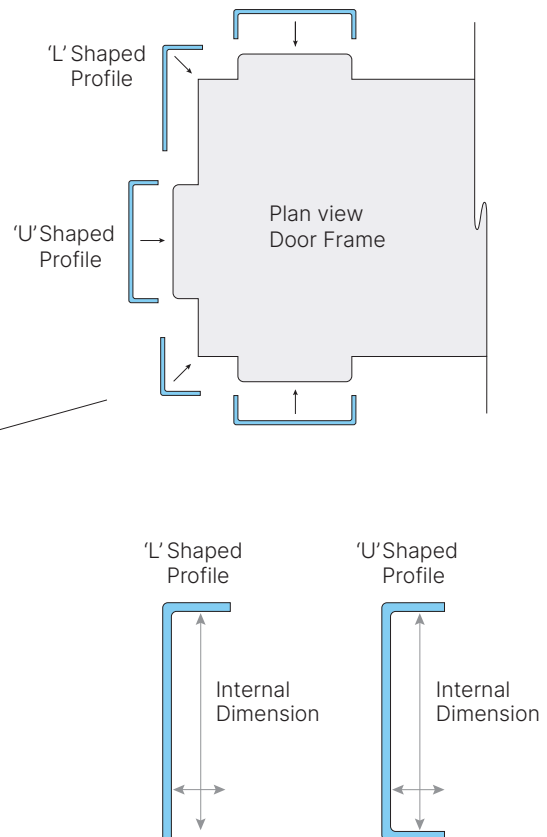
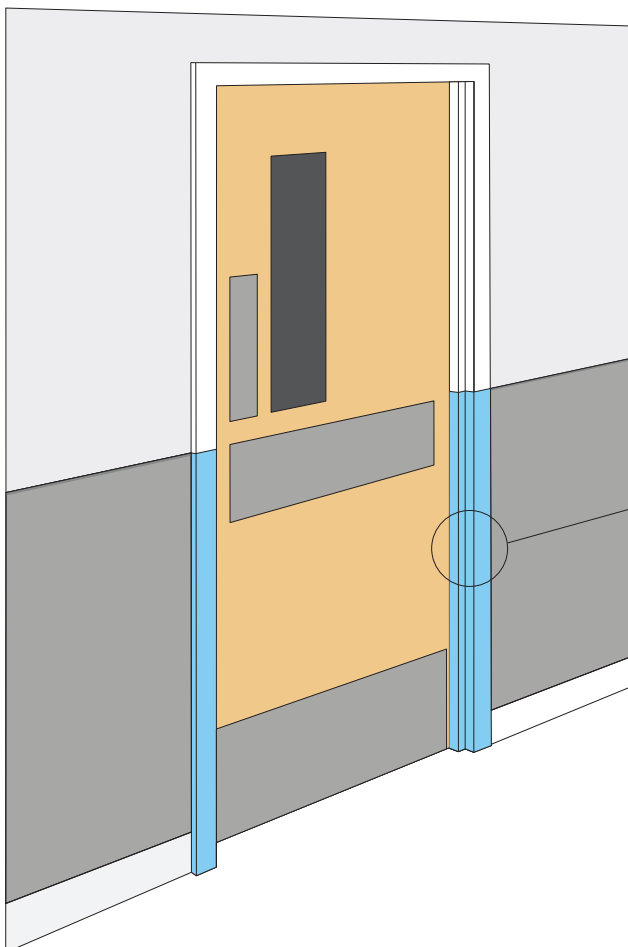

Corner guards (Push side only)

Door frames are often subject to high levels of impact from both pedestrian and wheeled traffic. Corner guards provide robust protection for door frame edges which are vulnerable to damage caused by a funnelling effect around door openings.

For lead times and quotations for bespoke forming, contact Gradus Technical Support on 01625 428922

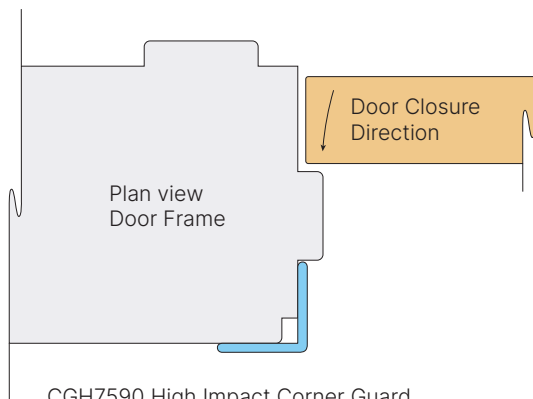

CGH7590 High Impact Corner Guard
(fitted over frame architrave leaving gap)
see page 104 for full product details

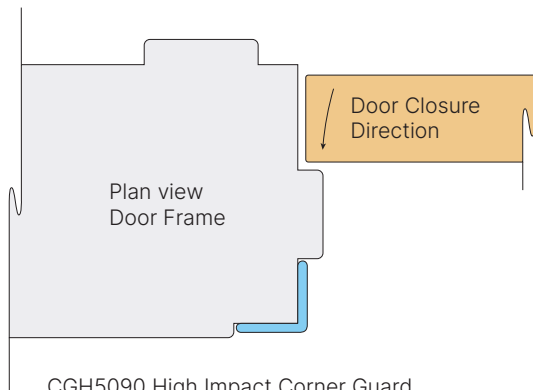

CGH5090 High Impact Corner Guard
(fitted between door stop & architrave)
see page 104 for full product details

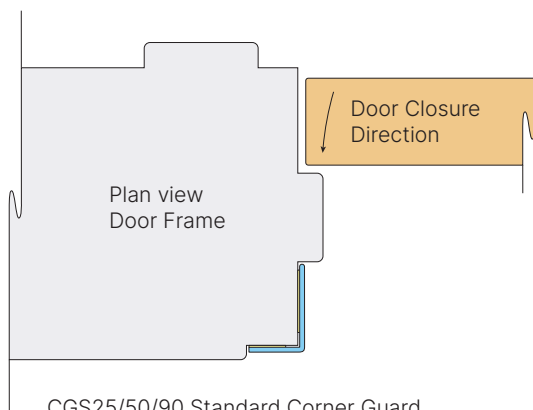

CGS25/50/90 Standard Corner Guard
Surface Mounted (trimmed down to suit site dimensions)
see page 106 for full product details

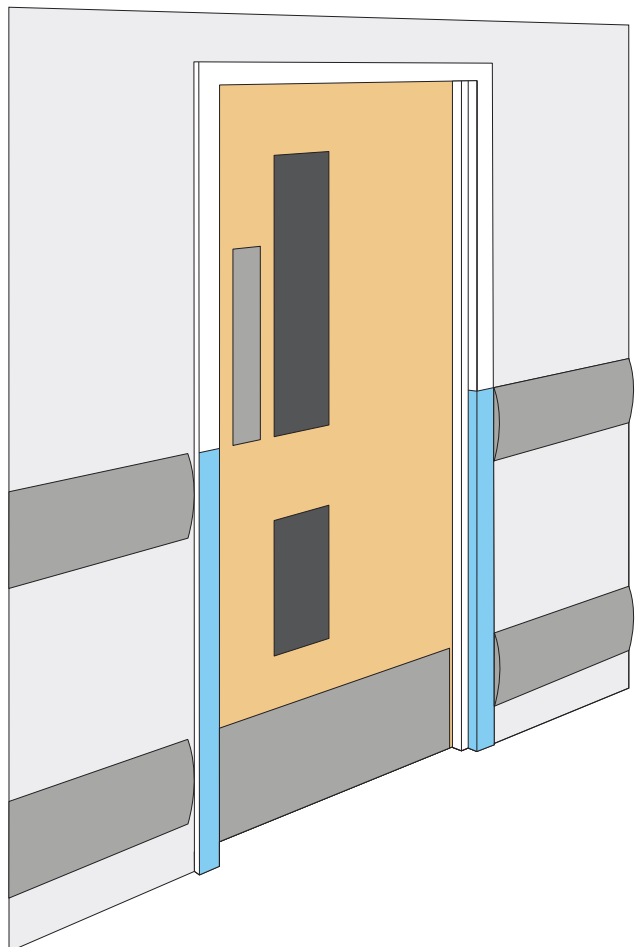

Floor Mounted Protection

Introduction

Gradus floor mounted protection is designed to protect buildings and equipment from damage by providing both a visual and physical barrier to help minimise damage when impact occurs. Pedestrian safety is also improved by keeping vehicles and pedestrians separate which helps to minimise the risk of accidents. This comprehensive range is ideal for applications such as service areas, loading bays and car parks.





Stainless Steel Bollard



Stainless Steel Floor Rail System



Steel Core Protection Post



Galvanised Steel Bollard

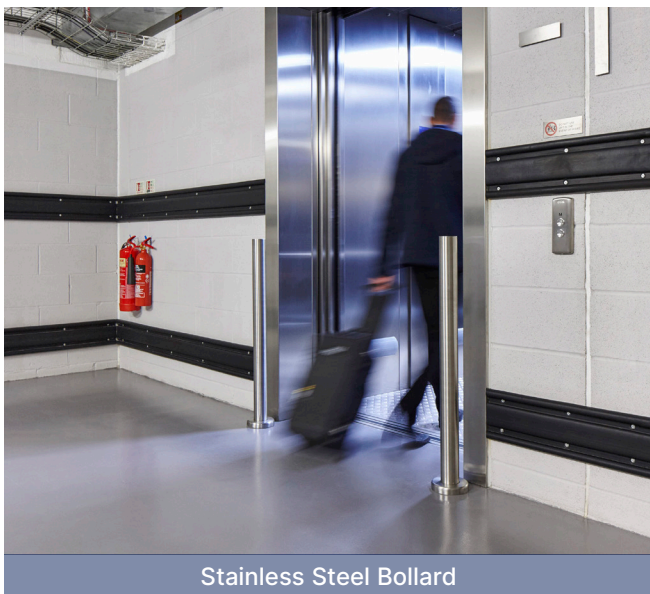

Stainless Steel Bollard



Flexible Protection Post

Stainless Steel Floor Rail System

Gradus stainless steel floor systems provide the ideal protection solution for surfaces that are not suitable for wall fixings, such as counters and glass partitions. Floor systems are specifically designed for keeping wheeled traffic away from the walls and can help create a sophisticated, unobtrusive finish for a modern design scheme.

Features

- > Ideal alternative to wall guards where wall fixings are not possible such as curtain walling or glass partitioning
- > 304 grade stainless steel – Satin or Polished finish
- > Comprises 51mm diameter rail with various pillar options and accessories
- > Standard and heavy duty pillar and bracket options available for front and back of house applications
- > Supplied in 3.0m lengths
- > Can be curved – contact Gradus for radii information
- > Suitable for interior use



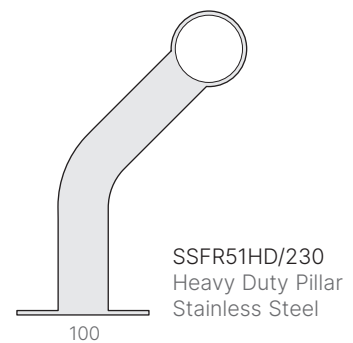
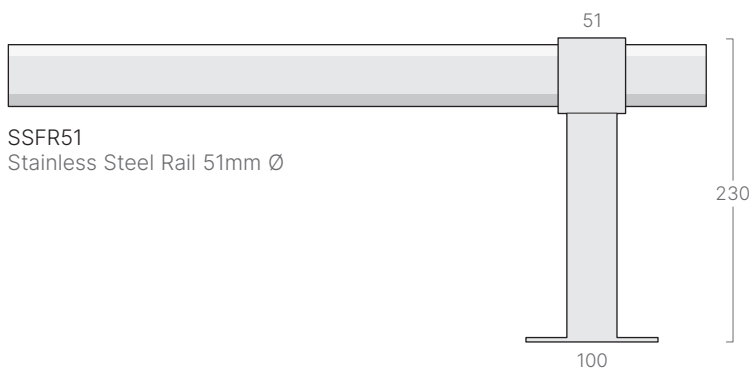
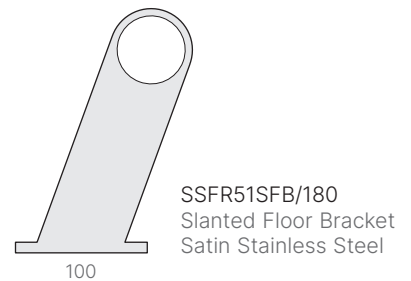
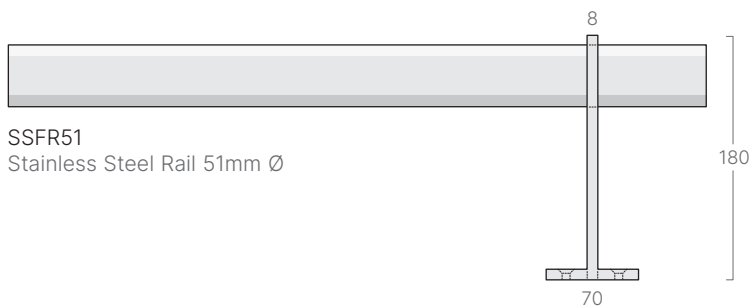
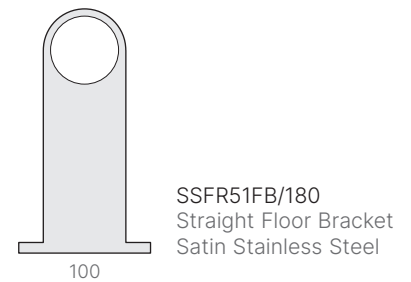
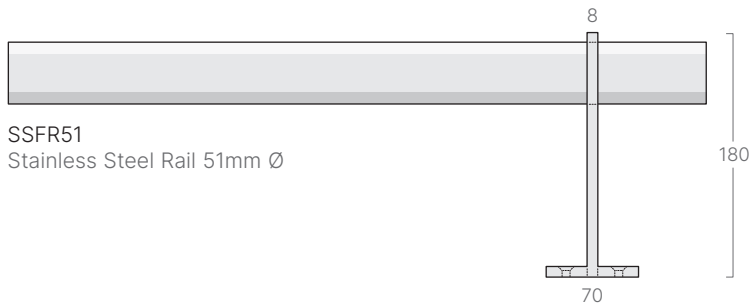

Components

Code	Description
SSFR51A90	90° Corner - Internal & External
SSFR51A135	135° Corner - Internal & External
SSFR51SP	Joining Splice
SSFR51EC	Flat End Cap
SSFR51RET/180	Floor Return 180mm (h)
SSFR51RET/230	Floor Return 230mm (h)

Stainless Steel Bollard

Ideal alternative to wall guards where surface fixings are not suitable such as counters, refrigeration units, isolated equipment and doors in hold open position.

Information

- > 2 profile options available in 2 heights
- > 304 grade stainless steel – Satin or Polished finish
- > Comprises bollard with base plate cover for concealed fixing
- > Suitable for interior use

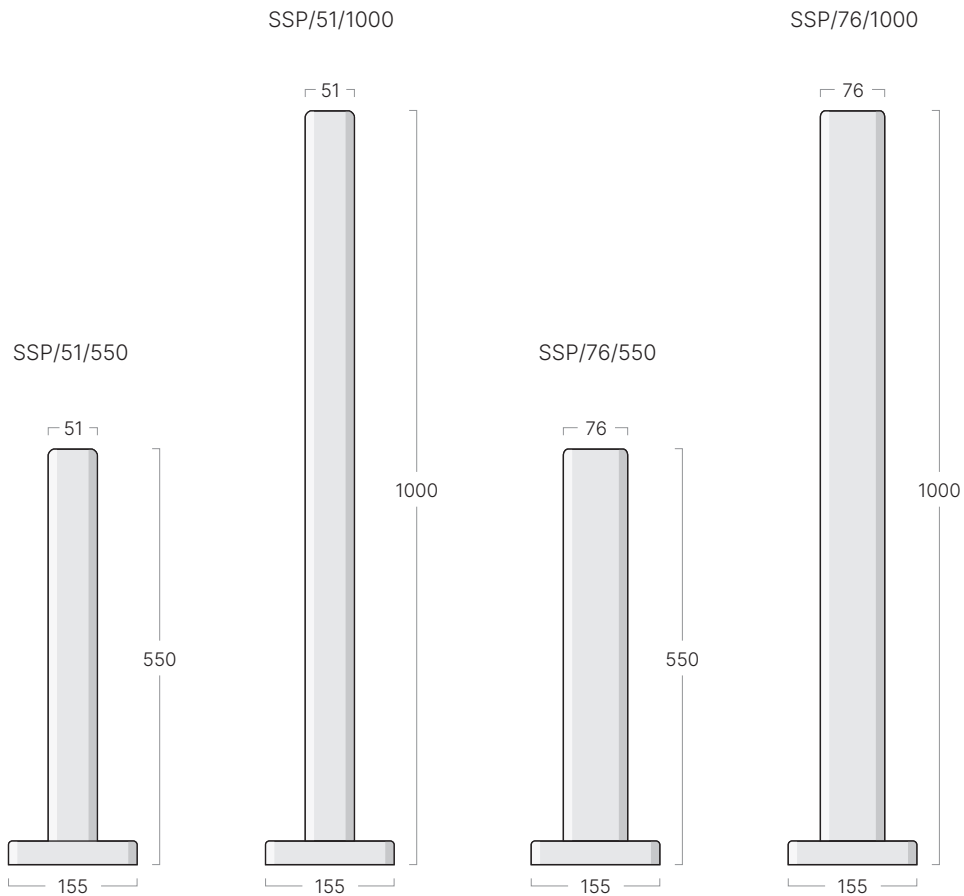

Visit: www.gradus.com
for full details



Dimensions shown are nominal
Illustrations are in mm



NBS Source
PARTNER

Galvanised Steel Bollard with Cover Kits

A range of heavy duty steel core bollards with high visibility cover kits offering a high performance, low maintenance solution with no repainting required.

Information

- > Supplied complete with square offset baseplate, with 4 fixing positions
- > Cover kits are manufactured from medium density polyethylene and are supplied in modular sections that are easy and quick to install for either new installations or instant refurbishment of existing bollards
- > Interior and exterior use. Covers are suitable for all weather temperatures (-40 to +90 degrees) and produced from a 7 year UV stabilised material formula
- > Optional Silver reflective band can be retro-fitted code: BA-REF-S - as shown in photo
- > Steel core fixings - code: FXG-TB16-150G
- > Tamper proof security fixing - code: BA-SFK

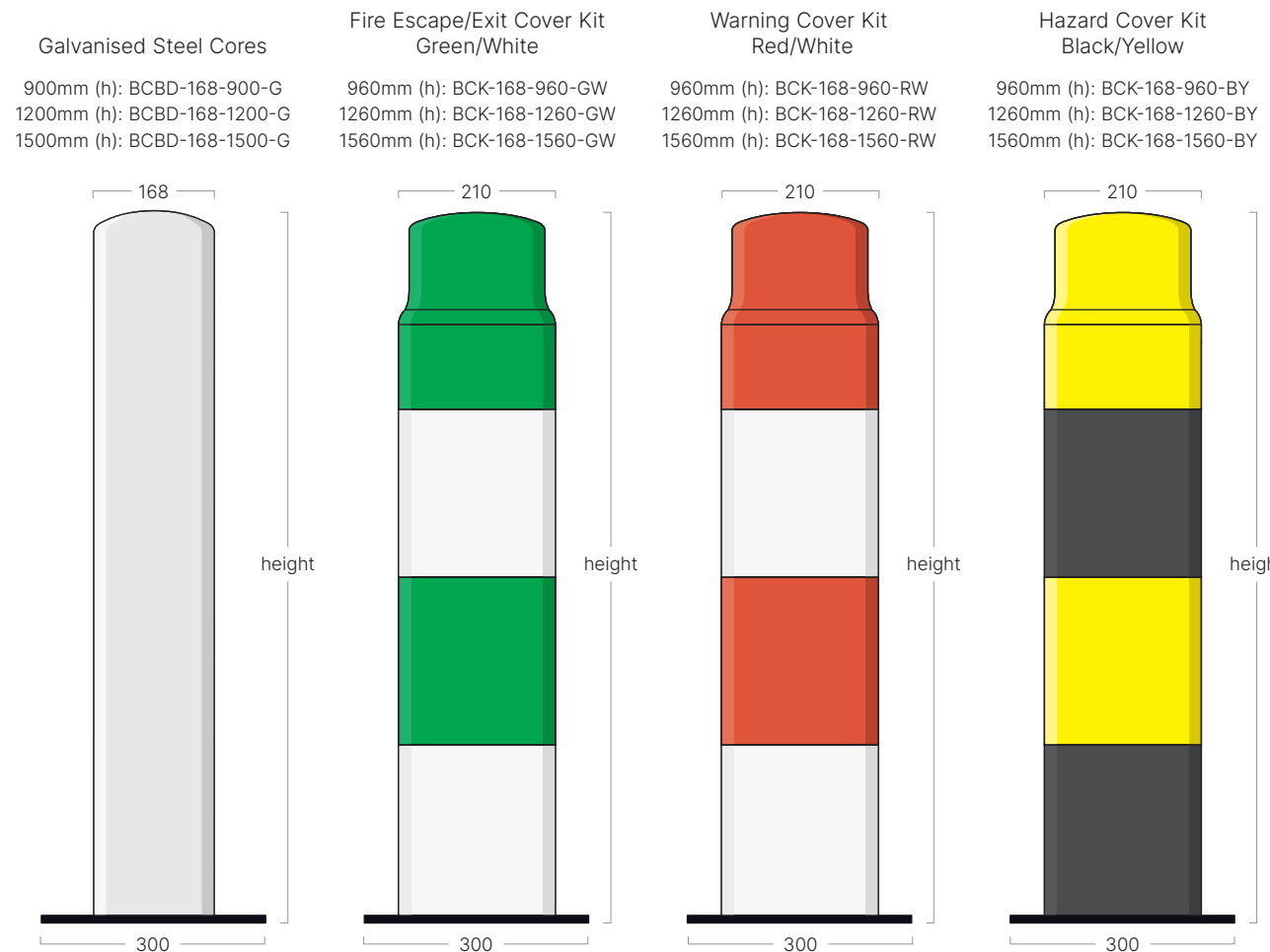
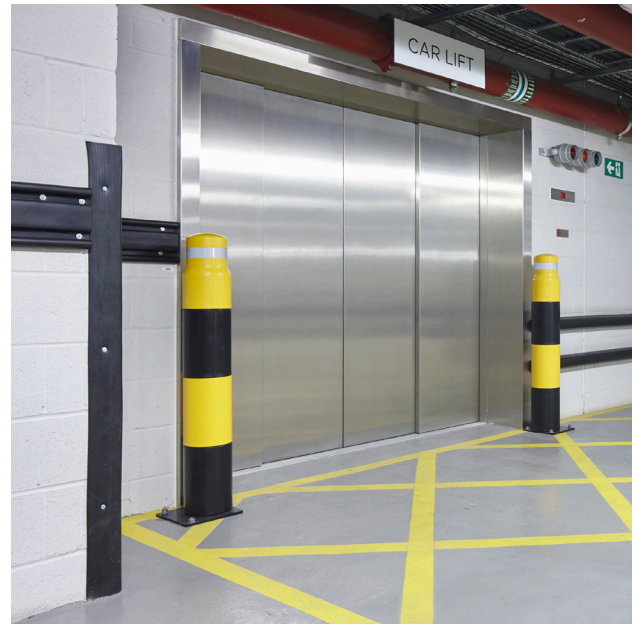

Steel Core Protection Posts

Protection posts offer medium impact, low-cost alternative to high-impact bollards. Ideal for protecting pedestrian doors, corners and vulnerable services and provide a low maintenance solution as they do not require repainting.

Information

- > Comprise a galvanised steel core and baseplate, a rotating polyethylene sleeve (Yellow RAL 1003) and rubber top caps incorporating diamond grade reflectors
- > Interior and exterior use. Suitable for all weather temperatures (-40 to +90 degrees)
- > Surface mounted galvanised steel baseplate (Offset 180mm square, 10mm thick)
- > Overall post diameter – 120mm (Steel core 114mm diameter)
- > Impact safety buffer
- > Includes fixings

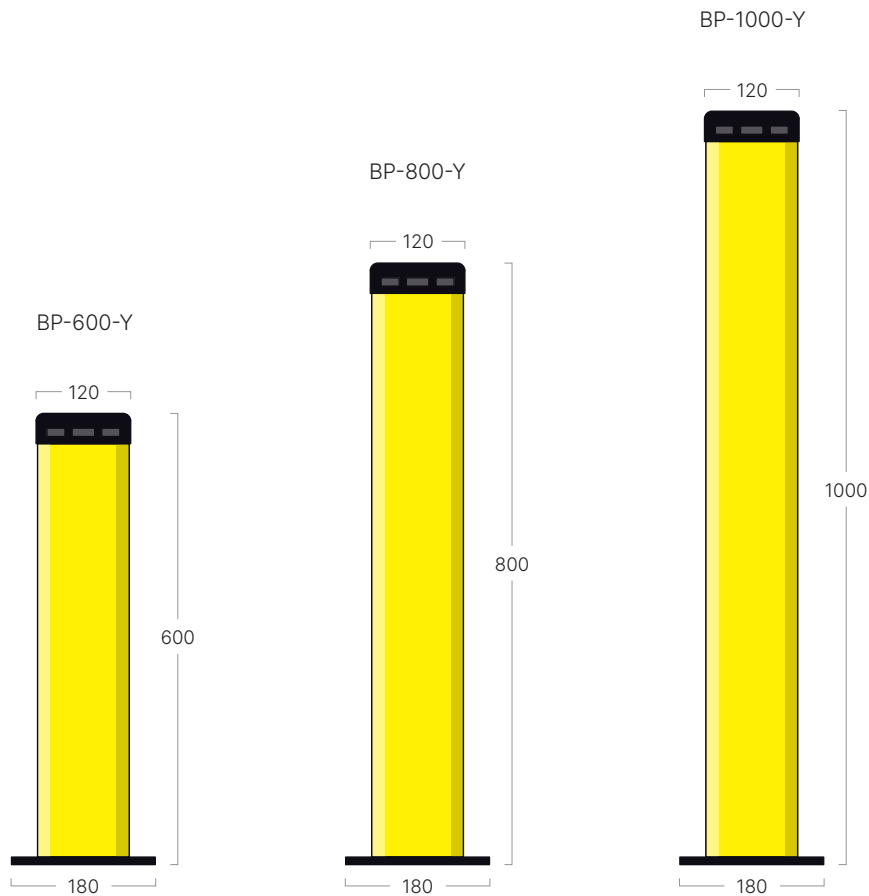

Visit: www.gradus.com
for full details



Dimensions shown are nominal
Illustrations are in mm



Flexible Protection Posts

Flexible Posts are designed to help control traffic flow and safely navigate vehicles in areas where risk of impact is high. They are ideal for guiding trolleys and other wheeled traffic in back-of-house service areas and for controlling vehicle movement in confined underground car parks.

Information

- > Designed to alert and guide vehicle users to safe routes in confined areas
- > If a collision does occur the product will bend under impact, alerting the driver and minimising damage to the vehicle
- > Extremely durable and will return back to shape following most vehicle collisions
- > Interior and exterior use
- > Option of black, silver or yellow reflectors

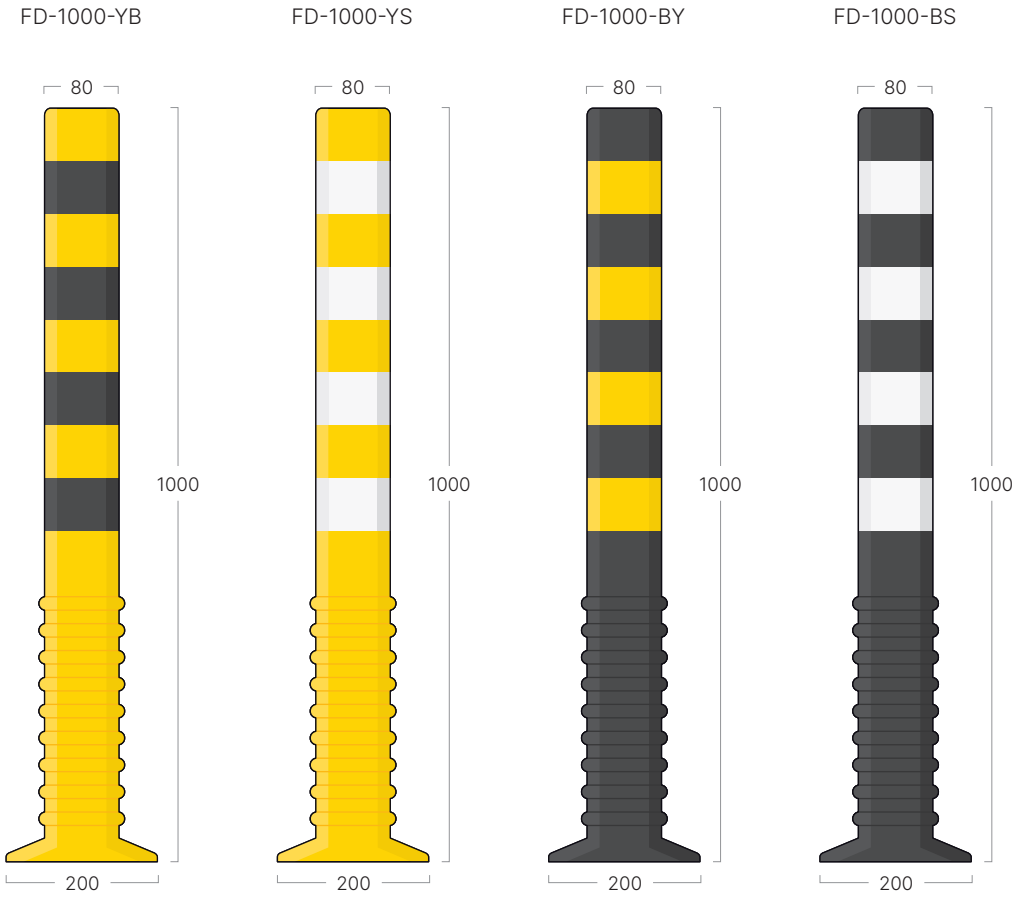

Specification Guidelines

Building Regulations and British Standards are designed to ensure the optimum specification of products through a combination of legislative requirements and guidance. The following extracts have been taken from the Building Regulations 2010, British Standard BS 8300-2:2018, Health Building Note 00-10 and Health Building Note 00-04 and show how Gradus products can be used to help satisfy these requirements, and help achieve an inclusive environment in line with the Equality Act 2010. For further details on this or any other aspect of Building Regulations and Standards contact Gradus Technical Support on 01625 428922.

Note: Details of standards and guidelines are correct at time of going to print, current standards should be checked prior to specifying.

Extracts from the Building Regulations

The Building Regulations 2010 - “Access to and use of buildings. Approved Document M - Volume 2: Buildings other than dwellings” 2015 edition

The latest version of Approved Document M 2010 is stated ‘for use in England’. Current building standards should be checked at time of specification for Wales, Scotland & Northern Ireland.

The Legal Requirement

Part M Access to and use of buildings other than dwelling
Access and Use

- M1. Reasonable provision shall be made for people to -
- gain access to : and
 - use the building and its facilities

Access to extensions to buildings other than dwellings M2.
Suitable independent access must be provided to the extension where reasonably practicable.

Gradus advice and recommendations for the Building Regulations Approved Document M are detailed in blue text. For further details contact Gradus Technical Support on 01625 428922.

Approved Document M

Approved documents are intended to provide guidance. Much of the guidance in the approved document is based on BS 8300. The guidance contained in Approved Document M is designed to indicate one way in which requirements may be met. There may be other equally satisfactory ways of meeting the requirements.

Entrance Lobbies

- 2.29 Entrance lobbies will satisfy Requirement M1 or M2 if:
- Any columns, ducts and similar full height elements that project into the lobby by more than 100mm are protected by a visually contrasting guard rail.
 - Protruding elements can be highlighted with products such as SureProtect Endure sheet, which can be formed around the element, additionally wall guards and corner guards can be used.*

Internal Doors

- 3.8 The presence of doors, whether open or closed, should be apparent to visually impaired people through the careful choice of colour and material for the door and its surroundings.
- For example, when a door is open, people with impaired sight should be able to identify the door opening within the wall, as well as the leading edge of the door.

- 3.10 Internal doors will satisfy Requirement M1 or M2 if:
- All door opening furniture contrasts visually with the surface of the door.
 - The door frames contrast visually with the surrounding wall
 - The surface of the leading edge of any door that is not self-closing, or is likely to be held open, contrasts visually with the other door surfaces and its surroundings.
- SureProtect Endure kickplates, pushplates and door edge protectors, along with door frame guards can be used to highlight and protect the door in a colour that contrasts to the door and wall.*

Corridors and passageways

- 3.14 Corridors & passageways will satisfy Requirement M1 or M2 if:
- Elements such as columns, radiators and fire hoses, do not project into the corridor, or where this is unavoidable, a means of directing people around them, such as a visually contrasting guard rail, is provided.
 - Protruding elements, such as columns, can be highlighted with products such as SureProtect Endure sheet, rubrails, wall strips, wall guards, handrails and corner guards.*

Handrails to external stepped and ramped access

Note: Gradus handrails are not suitable for stepped and ramped access, however, these guidelines are considered best practice guidelines for all types of handrails.

Similar guidelines can also be found in BS 8300-2:2018 under 10.3.2 Handrail Design (see page 132).

Design considerations

- 1.34 People who have physical difficulty in negotiating changes of level need the help of a handrail that can be gripped easily, is comfortable to touch and, preferably, provides good forearm support.
- Made from PVC-u or timber, Gradus handrails have a comfortable grip with a smooth, safe finish which is not cold to the touch.*
- 1.35 Handrails should be spaced away from the wall and rigidly supported in a way that avoids impeding finger grip.
- Gradus SHR40 and Gradus THR450 Timber Handrail are designed to meet the guidelines in BS 8300-2:2018 and Approved Document M 2010 (2015 edition) with dimensions as stated.*
- 1.37 Handrailing to external ramped and stepped access will satisfy Requirement M1 or M2 if:
- It contrasts visually with the background against which it is seen, without being highly reflective.
 - A wide range of colours is available, allowing a handrail to be selected in a colour that contrasts to the background.*
 - Its surface is slip resistant and not cold to the touch.
 - Gradus handrails are either made from timber or have a textured PVC-u cover which makes them slip resistant and not cold to the touch.*
 - It terminates in a way that reduces the risk of clothes being caught.
 - All Gradus handrails return to the wall, minimising the risk of snagging.*
 - Its profile is either circular with a diameter of between 32 and 50mm, or non-circular, 50mm wide and 39mm deep having rounded edges with a radius a minimum of 15mm (see diagram 7).
 - There is a clearance of between 50 and 75mm between the handrail and any adjacent wall surface.

The Building Regulations, British Standards and Construction Guidelines for specifying the appropriate Gradus product

- (k) There is a clearance of at least 50mm between a cranked support and the underside of the handrail.
- (h), (j) Gradus SHR40 Handrail and Gradus THR450 Timber Handrail are (k): designed to meet the guidelines in BS 8300-2:2018 + and Approved Document M 2010 with dimensions as stated. (see diagram 7 below)

Relationship with guidance in Approved Document K (Protection from falling collision and impact)

Where applicable, parts of this Approved Document state that the requirements of Part M will be satisfied by compliance with the applicable parts of the guidance with Approved Document K (Protections from falling, collision and impact). Compliance with these applicable requirements set out in Approved Document K in these circumstances will be regarded as compliant with a relevant design standard for the purposes of regulation 9 and the Schedule to the Regulations.

Handrails to internal steps, stairs and ramps

Design considerations

- 3.54 The design considerations for handrails are as those for 'Handrails to external stepped and ramped access' in 1.34 to 1.36.
- 3.55 Handrails to internal steps. Stairs and ramps will satisfy Requirement M1 or M2 if they comply with Approved Document K, sections 1-3.

Source:

Contains public sector information licensed under the Open Government Licence v 3.0.
To view this license visit <http://www.nationalarchives.gov.uk/doc/open-government-licence/version/3/>

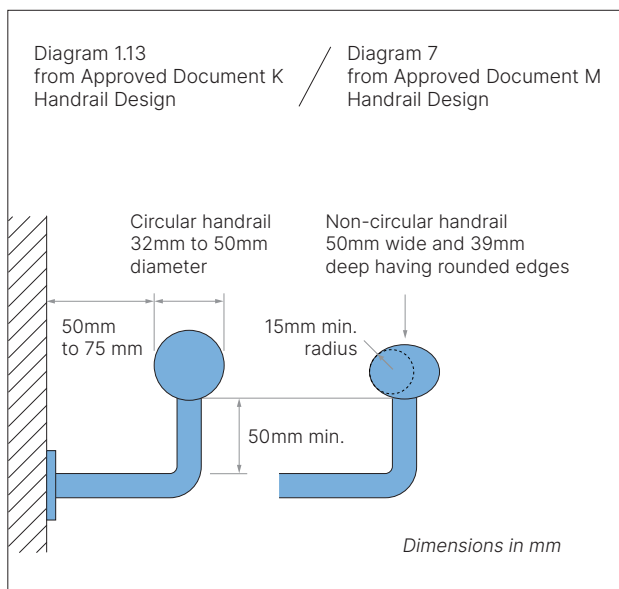

Approved Document K

“Protection from falling, collision and impact” K1 Stairs, ladders and ramps

(Effective April 2013 – for use in England)

Note: Approved Document K (April 2013) is stated for use in England only. Current building standards should be checked at time of specification for Wales, Scotland and Northern Ireland.

Handrail for stairs

Note: Gradus handrails are not suitable for use on stepped or ramped access, however, these guidelines are considered best practice guidelines for all types of handrail. Similar guidelines can also be found in BS 8300-2:2018 under 10.3.2 Handrail Design (see page 132).

For buildings other than dwellings

1.36 Provide handrails in accordance with all of the following.

- (d) Ensure that the handrail will contrast visually with the background against which it is seen, without being highly reflective
- (d) Gradus handrails are available in a wide range of colours allowing a handrail to be selected in a colour that contrasts with the background. All Gradus handrail colours have been measured to provide Light Reflectance Values* (LRVs) in order to provide the specifier with information to ensure that suitable contrast is achieved.
**These values have been measured using the CIE Y value in accordance with BS 8493:2008+A1:2010.*
- (e) Use a surface for the handrail that is slip-resistant and which, in locations subject to extremely cold or hot temperatures, does not become excessively cold or hot to touch. In areas where resistance to vandalism or low maintenance are key factors, use of metals with relatively low thermal conductivity may be appropriate.
- (e) Made from PVC-u or timber, Gradus handrails have a comfortable grip with a safe, slip-resistant finish that is neither hot nor cold to the touch. The materials used will not cool or heat excessively in extremes of temperature.
- (g) See Diagram 1.13
- (g) Gradus SHR40 handrail, Gradus THR450 Timber handrails and Gradus Dual Rail are designed to meet the guidance in BS 8300-2:2018 plus Approved Document M and Approved Document K of The Building Regulations 2010 with dimensions stated (see diagram 1.13 to the left).

Source:

Contains public sector information licensed under the Open Government Licence v 3.0.
To view this license visit <http://www.nationalarchives.gov.uk/doc/open-government-licence/version/3/>

Specification Guidelines

Extracts shown below show examples of best practice

BS 8300-2:2018

Design and Buildings and their approaches to meet the needs of disabled people - Code of Practice.

This standard provides guidance or good practice in the design to address and integrate the access requirements of all people, irrespective of their personal circumstances, as part of mainstream design, with the aim to achieve an inclusive environment. Gradus advice and recommendations for BS 8300-2:2018 are detailed in blue text. For further details contact Gradus Technical Support on 01625 428922.

10.3.2 Handrail Design

Commentary on 10.3.2

A handrail should be:

- (a) Easy and comfortable to grip with no sharp edges, but able to provide adequate resistance to hand slippage;

Note 1:

An external perimeter of between 100 mm and 160 mm is the optimum size to provide a power grip around a handrail. Suitable profiles include circular or oval. A flatter profile gives better forearm support

- (a): Available in a range of materials and finishes including PVC-u, aluminium, timber and stainless steel
- (b) Continuously graspable along its entire length without obstruction;

Note 2:

Well spaced handrail supports are not considered an obstruction (see 10.3.3).

- (b): Gradus handrails are designed to provide a continuous uninterrupted grip, with accessories such as internal and external corners, allowing the handrail to navigate changes in direction.
- (c) Finished so as to provide visual contrast with the surroundings against which it is seen;
- (c): The wide range of colours available allows a handrail to be selected in a colour that contrasts with the wall finish.

All Gradus handrail colours have been measured to provide Light Reflectance Values* (LRVs) in order to provide the specifier with information to ensure that suitable contrast is achieved.

*These values have been measured using the CIE Y value in accordance with BS 8493:2008+A1:2010

10.3.3 Handrail dimensions and spacings

Any circular handrail should have a diameter of between 32mm and 50mm.

There should be a clearance of between 50mm and 75mm between a handrail and any adjacent wall surface, and any handrail support should meet the handrail, centrally, on its underside. The clearance between the bottom of the rail and any cranked support, or any continuous balustrade, should be at least 50mm to minimise the risk of the handrail supports interrupting the smooth running of a person's hand along the rail.

Gradus SHR40 handrail and THR450 Timber handrail are designed to meet the dimensions stated (see pages 80).

Note:

Similar guidelines can also be found in The Building Regulations Approved Document M under 'Handrails to external stepped and ramped access' (see page 130).

Gradus handrails are not suitable for stepped and ramped access, however, these guidelines are considered best practice guidelines for all types of handrail.

11 Surface Finishes

Commentary on Clause 11

The extent to which floor, wall, door and ceiling surfaces enable For example, people who are blind or partially sighted, people who are deaf and hard of hearing, and people who have sensory/neurological processing difficulties aid people to find their bearings and maintain their independent use of a building is influenced by:

- The colour, pattern, light reflectance value (LRV) and texture of the surfaces;
All Gradus products have an LRV to ensure that a suitable choice can be made to contrast between surfaces. For instance, kickplates and pushplates can be used to highlight the door. In addition, handrails that contrast to the background can provide support and direction.
- The treatment of components and finishing elements, such as doors, architraves, skirtings, handrails, etc. which define, or are contained within, these surfaces;
Through the use of colour, Gradus products can be used to colour code different floors or departments, create wayfinding or highlight protruding elements such as columns.

11.1 Visual Characteristics

Differences in LRV should be used to assess the degree of visual contrast between surfaces such as floors, walls, doors and ceilings and between key fittings/fixtures and surrounding surfaces.

All Gradus products have an LRV to ensure that a suitable choice can be made to contrast between surfaces. For instance, kickplates and pushplates can be selected to highlight the door, and handrails can be selected to contrast with the background.

11.4 Wall Surfaces

Large, repeating patterns that incorporate bold, contrasting colours should not be used for the wall surfaces in parts of a building where visual acuity and stress reduction are critical. Service outlets, light switches, and other functional elements on the surface of walls should be distinguishable from the wall, using visual and textural contrast.

Gradus SureProtect Endure protective PVC-u sheet is available in 35 solid colours for visual contrast and clarity to be achieved. This allows other functional elements on the wall surface to be highlighted using Light Reflectance Values to ensure suitable visual contrast.

Permission to reproduce extracts from BS 8300-2:2018 is granted by the BSI Standards Limited. No other use of this material is permitted.

The complete British Standard can be purchased from the BSI online shop: <https://shop.bsigroup.com>

The Building Regulations, British Standards and Construction Guidelines for specifying the appropriate Gradus product

Extracts from HBN 00-10 Performance requirements for building elements used in healthcare facilities HBN 00-10 (supersedes HTM 69)

HBN 00-10

Part B: Walls and ceilings

This document outlines the policy and performance requirements for building elements used in healthcare facilities. These requirements are a set of essential standards of quality and safety that building elements must comply with. It supersedes Health Technical Memoranda 56, 60, 61, 64, 68 and 69. Gradus advice and recommendations for HBN 00-10 are detailed in blue text. For further details contact Gradus Technical Support on 01625 428922.

Performance Requirements:

- 2.9 Smooth, hard, seamless and impervious surfaces are required in clinical areas as they are easier to clean.
- 2.12 Wall finishes should not comprise materials that promote or sustain the growth of fungi and micro organisms.
- 2.15 Wall finishes are to be durable and able to withstand minor impacts without the need for additional wall protection.
- 2.16 Wall finishes are to be impermeable and easily wiped over if necessary and not be physically affected or degraded by detergents and disinfectants.

Gradus SureProtect Pure offers a smooth impermeable surface finish which is easy to clean and does not support the growth of bacteria or fungus. It is 2.5mm thick and through coloured in order to resist and conceal the effects of impact and abrasion.

Requirements for impact protection:

Impact protection is intended to help reduce the incidence and severity of damage to walls and partitions in healthcare buildings so that their performance is maintained.

Protection fittings include:

- Handrails
- Crash rails
- Combination rails
- Corner guards
- Bed head protectors

Gradus wall protection products are tested for impact resistance and are designed to absorb impact without damage to the substrate. The majority of profiles are modular in design, allowing damaged covers to be easily replaced without disruption.

Note:

This section does not cover the need for handrails as part of a protection system, as this is covered by the client's project-specific needs and the Equality Act 2010 (see also Health Building Note 00-04 – 'Circulation and communication spaces'). Nevertheless, this does not preclude the use of handrails as part of a protection system.

Performance Requirements:

Materials and colours should comply with the requirements of the Equality Act 2010, where appropriate.

Gradus wall protection profiles are available in 35 colours, all of which are measured for Light Reflectance Values, in order to ensure profiles can be selected to provide suitable visual contrast where required.

Materials for handrails are PVC-u or timber and offer a comfortable grip with a smooth, safe finish which is not cold to the touch.

Source:

Department of Health Estates & Facilities Division:
Core Elements
Health Building Note 00-10 Part B: Walls and ceilings
Contains public sector information licensed under the
Open Government Licence v 3.0
To view this license visit <http://www.nationalarchives.gov.uk/doc/open-government-licence/version/3/>

Specification Guidelines

Extracts from HBN 00-04 – ‘Circulation and communication spaces’

HBN 00-04

Health Building Note 00-04 provides guidance on the design of circulation and communication spaces in hospitals and other healthcare buildings, including corridors, internal lobbies and stairs, and lifts. It also provides supporting information on doors and handrails. Gradus advice and recommendations for HBN 00-04 are detailed in [blue text](#). For further details contact Gradus Technical Support on 01625 428922.

2 General design and functional requirements

Visual and colour contrast

- 2.9 Contrasting handrails/crash rails may be fitted to act as navigation tools

The wide range of colours available allows a handrail to be selected in a colour that contrasts with the wall finish. All Gradus handrail colours have been measured to provide Light Reflectance Values* (LRV) in order to provide the specifier with information to ensure that suitable contrast is achieved.

*These values have been measured using the CIE Y value in accordance with BS 8493:2008+A1:2010.

3 Corridors

Handrails

- 3.29 Handrails should be fitted in main communication routes (that is, main corridors between departments) and in departmental departments as required. See specific departmental guidance for further information.

See [Gradus handrails, dual rails and combination rails \(p.80\)](#).

7 Handrails

Shape and size

- 7.3 Handrails should be easy to grasp; the size and shape should allow a firm but comfortable grip with the whole hand.
- 7.4 Handrails that are too small are uncomfortable and provide an unsatisfactory grip, whereas handrails that are too large are difficult to grip for people with weak or arthritic hands
- 7.5 A handrail that is round in cross section with a diameter of 40-45mm is recommended. Oval handrails with dimensions of 38mm x 50mm wide are acceptable. In both cases the longer dimension should be horizontal.
- 7.6 Handrails with large square or rectangular cross-section should be avoided.

All Gradus handrails feature a round grip in line with the recommendations and the guidelines in BS 8300-2:2018 and Approved Document M Volume 2 2010 (2015 edition).

Clearance

- 7.7 Handrails should allow enough space between the rail and the adjacent wall (or any other obstacle) for hands to pass without scraping knuckles and to aid those who want to use the rail as a support for the whole forearm.
- 7.8 A clearance of 60-75mm is recommended, as this allows the forearm to be rested on the rail without any danger of it getting trapped.

[Gradus SHR40, THR40 and D200 Dual Rail meet the recommended clearance dimension. Similar guidelines can also be found in BS 8300-2:2018 and Approved Document M 2010 \(2015 edition\).](#)

Provision in corridors

- 7.19 Handrails should return into recessed doorways and openings, but otherwise be continuous to aid navigation.
- All Gradus handrails are offered with a complete range of accessories to allow continuous runs around both internal and external corners and for safe returns to walls to take into account doorways and openings (see page 80).

Handrails in association with wall protection

- 7.20 Where handrails and wall protectors are provided:
- a minimum vertical clearance of 50mm must be maintained between the handrail and wall protector;
- Gradus handrails are designed to meet the dimensions stated (see page 80), incorporating a 50mm clearance between the handrail and wall guard element of the profile.
- All other Gradus handrails and wall guards are designed to work together and can be installed to the dimensions stated.

- 7.22 Handrails should be:

- easily visible, that is, contrast visually with the surface to which they are fixed;
 - smooth and free from any abrasive elements;
 - neither too cold nor too hot to the touch.
- Made from PVC-u or timber, Gradus handrails have a comfortable grip with a smooth, safe finish that is not cold or hot to the touch

Source:

Department of Health Estates & Facilities Division:
Core Elements
Health Building Note 00-04 : Circulation and communication spaces
Contains public sector information licensed under the Open Government Licence v 3.0
To view this license visit <http://www.nationalarchives.gov.uk/doc/open-government-licence/version/3/>

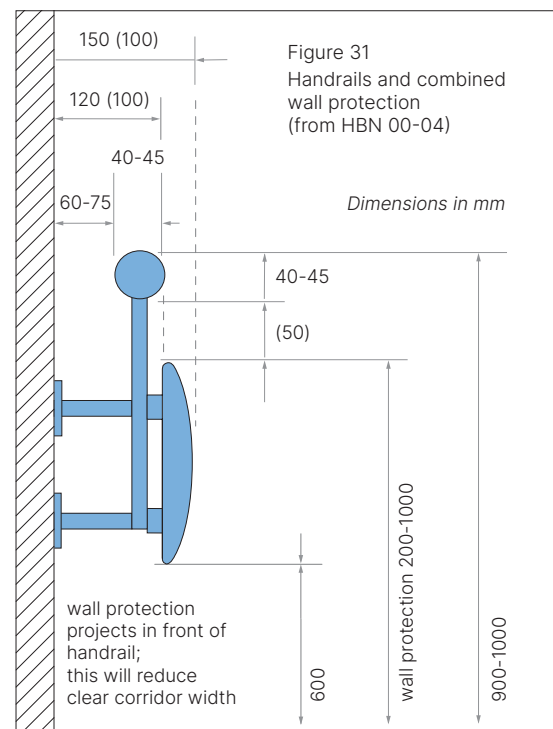

Drawings are extracts from guidance.

Source:

Department of Health Estates & Facilities Division:
Core Elements – Health Building Note 00-04: Circulation and communication spaces Crown copyright

The Building Regulations, British Standards and Construction Guidelines for specifying the appropriate Gradus product

Extracts shown below show examples of best practice

Mat (Material)

05 Designing for robustness

No. of credits available: 1

Minimum standards: No

Aim

To recognise and encourage adequate protection of exposed elements of the building and landscape, therefore minimising the frequency of replacement and maximising materials optimisation.

Assessment Criteria

The following is required to demonstrate compliance for:

One credit

1. Areas of the building have been identified (both internal and external) where vehicular, trolley and pedestrian movement occur.
2. The design incorporates suitable durability and protection measures or design features/solutions to prevent damage to the vulnerable parts of the building. This must include, but is not necessarily limited to:
 - a. Protection from the effects of high pedestrian traffic in main entrances, public areas and thoroughfares (corridors, lifts, stairs, doors etc).
 - b. Protection against any internal vehicular/trolley movement within 1m of the internal building fabric in storage, delivery, corridor and kitchen areas.
 - c. Protection against, or prevention from, any potential vehicular collision where vehicular parking and manoeuvring occurs within 1m of the external building façade for all car parking areas and within 2m for all delivery areas.

CN2 Suitable Durability

Suitable durability and protection measures to vulnerable parts of the building can include:

1. Bollards/barriers/raised kerbs to delivery and vehicle drop-off areas 2.
2. Robust external wall construction, up to 2m high
3. Corridor walls specified to Severe Duty (SD) as per BS 5234-2 and, for healthcare buildings, Health Technical Memorandum 56 – Partitions
4. Protection rails to walls of corridors
5. Kick plates/impact protection (from trolleys etc) on doors
6. Hard-wearing and easily washable floor finishes in heavily used circulation areas (i.e. main entrance, corridors, public areas etc)
7. Designing out the risk without the need for additional materials specification to protect vulnerable areas.

CN3 Vehicle impact protection

Any vehicle impact protection measures specified must be positioned at an adequate distance from the building to protect the fabric from impact from any vehicle with a measurable overhang of the body from the wheel track, in particular for any goods delivery areas.

In vehicle movement areas only; where the specification of external robust wall construction is specified to comply with the credit, additional protection must be provided to ensure against potential damage to the robust facade from vehicle movement i.e. specifying bollards or protection rails.

CN4 Preventing excessive material use

The specification or design measures chosen should reflect the need to balance the additional specification of materials with the need to protect building elements to minimise their replacement, ensuring against excessive material use and promoting materials optimisation.

CN5 Public / Common Areas

Consideration should be given to materials specification in public/common areas (especially public waiting areas and toilet areas) to provide protection against potential malicious or physical abuse in as far as it is possible.

CN6 Sales areas (retail)

In any sales areas, where customer goods trolleys will be used, protection must be provided to vulnerable parts of the building (such as glass curtain walling etc.) within 1m of trolley movement.

Schedule of Evidence

Req.

Design Stage

Post Construction Stage

All

Design drawings illustrating vulnerable areas/parts of the building.

Design drawings and/or relevant section/clauses of the building specification or contract confirming the durability measures specified.

BREEAM Assessor's site inspection report and photographic evidence AND/OR 'As built' drawings.

[Gradus offers a comprehensive service for all aspects of wall protection ranging from advice on specification for supply only projects, through to a complete project management service for the supply and installation of Gradus Wall Protection Systems.](#)

[Gradus considers factors that would influence the specification in line with 'Mat 05 Designing for robustness' and facilitates this with extended service levels including on-site surveys, measuring and face-to-face advice from trained specification consultants.](#)

[Gradus can help with the assessment of a building in order to establish the types of wall protection required and appropriate locations/levels where it should be installed, ensuring products selected meet the requirements of the building.](#)

Source:

BREEAM New Construction Non Domestic Buildings Technical Manual - SD5073-5.0 : 2011



Gradus is a member of NBS Source to assist architects and other specifiers for guidance when writing specifications.

BIM

In line with the UK Government's BIM (Building Information Modelling) mandate, Gradus now has BIM objects available for most of our wall protection profiles.

The Government Soft Landings (GSL) policy came into full force in 2016, alongside BIM Level 2, to reduce costs and improve performance of asset delivery and operation.

Gradus BIM objects provide up-to-date, accurate data about products, providing you with the relevant technical information to build into your projects. You can download our BIM objects free of charge on NBS Source www.source.thenbs.com

Gradus PVC-u Product Characteristics

Gradus PVC-u products have undergone a series of rigorous tests to ensure they will perform to expectation throughout their life. Tests are undertaken in Gradus' purpose-built testing facilities, by independent testing houses and through observing and testing products in-situ. With over 50 years experience Gradus provides peace of mind to its customers.

<p>PVC-u</p> <p>PVC-u Sheet Material</p> <p>PVC-u profile Material</p>	<p>Unplasticised polyvinyl chloride is through coloured to conceal the effects of impact and abrasion.</p> <p>Fire Performance: Gradus SureProtect Endure, SureProtect Design and SureProtect Pure Wall Protection Systems meet the European Standard EN13501-1 Fire classification of construction products and building elements - EN 13501-1: Class B Fire/s3 Smoke</p> <p>Gradus PVC-u profile material has been tested in accordance with EN ISO 11925-2:2010 and EN 13823:2010+A1:2014 and classified: EN 13501-1 Class B Fire / s2 Smoke</p> <p>NB: Please refer to manufacturers installation guidelines for recommended adhesives.</p> <p>Chemical Resistance: Tested in accordance with EN ISO 175:2010 Plastics – determination of the effects of liquid chemicals including water. The results show that the products as tested are resistant to most commonly used chemical solutions.</p> <p>Bacterial Resistance: Tested in accordance with EN ISO 846:1997-Part C (Bacterial growth test) Evaluates the effects and propagation of bacteria on plastic materials that are exposed to the environment. The results show that the products as tested did not support bacterial growth.</p> <p>Fungal Resistance: Tested in accordance with EN ISO 846:1997- Part A (Fungal growth test) Plastics – evaluation of the action of fungus. The results show that the products as tested did not support fungal growth.</p> <p>Impact Resistance: Tested in line with ISO 6603-1:2000 Determination of puncture impact test.</p> <p>VOC Testing – SureProtect Endure & SureProtect Design: France introduced regulations in 2011 relating to the labelling of building products used internally with regard to emissions of volatile polluting substances.</p> <p>SureProtect Endure has been tested for VOC emissions in accordance with ISO 16000. Emission test results after 28 days correspond to the emissions Class A of the French regulations on labelling of the products for wall cladding on their emissions of volatile pollutants (April 2011)</p>
<p>PVC-u Moulded Accessories</p>	<p>Returns, corners and brackets are hardwearing injection moulded thermoplastic, textured and colour matched to the PVC-u.</p>
<p>Aluminium</p>	<p>Durable alloy 6060-T6 grade or 6063-T6 to EN 573-3:2013</p>
<p>Product Support</p>	<p>Colour swatches, samples and further information are available on request from: Gradus Technical Support on 01625 428922 or visit www.gradus.com</p>
<p>Installation</p>	<p>Comprehensive installation instructions are available to download from the Gradus website www.gradus.com</p> <p>Installation details and advice are also available on request from Gradus Technical Support 01625 428922</p>
<p>Maintenance</p>	<p>Maintenance details are available on request from: Gradus Technical Support on 01625 428922</p>



Sunlight reflects off the ice in Saturn's rings and makes them sparkle!

GRADUS

Gradus Accessories Park Green Macclesfield Cheshire SK11 7LZ

For enquiries outside the UK and Eire contact Gradus International on +44 (0)1625 613780

Gradus International
England

Tel +44 (0) 1625 613780

Gradus Far East
Singapore

Tel: (+65) 6734 5933

call: 01625 428922
gradus.com

This catalogue supersedes and replaces all previous issues.

All designs, images and illustrations contained within this catalogue remain the copyright of Gradus Ltd.©

All trademarks, product names and codes detailed within this catalogue are the property of Gradus Ltd.